

EDITORIAL COMMENT

TRUER THAN THE TRUTH

As is shown in the article "Seeing and Hearing" in this issue, the mere avoidance of distortion, hitherto one of the main objects of the communications engineer, is by no means the end of the story. As Dr. Colin Cherry, the author, points out, the classical and mechanistic approach to the problem often ignores the real purpose of a communication system, which is to transmit information from person to person. Human beings cannot be modified to fit them into a communications chain; obviously the alternative is to modify the characteristics of the chain to suit their psychological needs.

The idea that art (which may be crudely defined as faking) can improve on nature (represented by fidelity of the transmitted signal) is not new. Long before the days of "hi-fi" Rudolf Pfenninger produced "caricature" sound effects which certainly succeeded in evoking the desired reactions in the listener's mind much more effectively than the most perfectly reproduced natural sounds. A good caricature is often truer than the truth. Corresponding improvements are possible in the visual transmission of information. For example, F. H. Brittain recently showed at an I.E.E. discussion meeting that a desired piece of information could be much more efficiently conveyed by a sketch in a few bold lines than by a highly detailed photograph. The sketch could have been transmitted recognizably by the Baird 30-line television system with a bandwidth of a few kc/s; the photograph, with all its redundant information, would need many Mc/s.

ELECTRONICS UP TO DATE

Ordinary English words sometimes change their meanings drastically, but usually such changes take many years—even centuries. The technical terms with which *Wireless World* and its readers are concerned may change much more rapidly. It now seems that the meaning of the word "electronics" is undergoing one of those quick changes.

A year or two ago, everything was simple enough. Among the less pedantic practitioners of the art, electronics was defined roughly as "radio-like techniques and devices, especially valves, applied to non-communication purposes." In more academic circles the accepted definition was the one originally put forward by the American Institute of Electrical Engineers and recently given world-wide currency in revised form in the 1956 International Electrotechnical Vocabulary: "That branch of science and technology which deals with the conduction of electricity in a vacuum, a gas and in semi-conductors, and with the utilization of devices based on these phenomena." According to that definition radio technology should rationally have been regarded as merely a branch of electronics, but there was a widespread conspiracy—or tacit understanding—to keep the two apart.

The sharp distinction commonly drawn between "radio" and "electronics," irrational though it was, may have served a useful purpose in the days when electronic devices for non-communication purposes were novelties. Now, most components and many techniques are freely interchangeable between the communications and non-communication branches of electronics; many of the practitioners are equally at home in either.

W
i
r
e
l
e
s
s

W
o
r
l
d

APRIL
1957

Vol. 63 No. 4

Transistors in Television

POINTERS AT THE TELEVISION SOCIETY'S EXHIBITION

THE ultimate aim of a transistorized television set does not seem quite so remote, now that radio-frequency and power transistors are coming on to the market—though it will be some time before the necessary types for amplification at v.h.f. become available. Some evidence of progress in this direction was to be seen at the recent Television Society's exhibition held in London. G.E.C., for example, were showing an experimental television receiver in which both the line and frame timebase oscillators were transistorized and also the respective sync separators. Moreover, a power transistor was used for the frame output stage.

Fig. 1 shows the transistorized part of the circuit. V1 is the line sync separator and V2 the frame sync separator and clipper, both of these transistors being experimental p-n-p types. The line timebase, V3, is an n-p-n transistor arranged in a blocking oscillator circuit. It gives a positive-going sawtooth waveform of about 45 V peak-to-peak which is used to drive the thermionic-valve line output stage. The frame timebase, V4, is also a blocking oscillator circuit, and it drives the frame output stage V6 through a buffer amplifier V5—all these transistors being experimental p-n-p types. With a supply tension of 30 V, the total consumption of the transistorized section is approximately 160 mA.

Although no transistors are available in this country for amplification at v.h.f., at least some appear to be working satisfactorily as oscillators at these frequencies—as was evident from two pieces of experimental test gear at the Show. The Ferguson transistorized pattern generator illustrated in Fig. 2

gives either a plain video signal (of 7 V peak-to-peak maximum) or a video-modulated r.f. carrier (of 50 mV r.m.s.) at a frequency of 56.75 Mc/s (Channel 3). The r.f. carrier is produced in a section containing two transistors with alpha cut-off frequencies of at least 30 Mc/s, and is crystal-controlled to maintain frequency stability. The remaining 39 transistors are divided between 21 types with an f_{CO} of 500 kc/s and 18 types with an f_{CO} of 5 Mc/s. The actual pattern produced by the generator is a black-on-white graticule, plus the normal synchronizing waveform. It has a fixed number of horizontal bars, while the number of vertical bars can be varied.

As can be seen from Fig. 2 the construction takes full advantage of the smallness of the transistors by using a number of printed circuit panels, which can be removed individually for servicing. The first panel carries a master video oscillator and mains locking circuit, the second a frequency divider chain, the third the sync waveform generators, while the fourth produces the complete video signal and the fifth generates the modulated r.f. signal. Power is supplied by 13.5-V dry batteries and the total consumption is only 650 mW. The weight of the instrument, including batteries, is 4½ lb.

The other transistorized test instrument on show was a wobulator, giving an r.f. output of 0.1 V in the television i.f. range of 31-41 Mc/s. Developed by Philco, it uses the well-known surface-barrier transistor for the r.f. oscillator (actually a Hartley circuit). The frequency of the oscillator is swept through the required range by a triangular waveform, which varies the permeability of a ferrite rod core

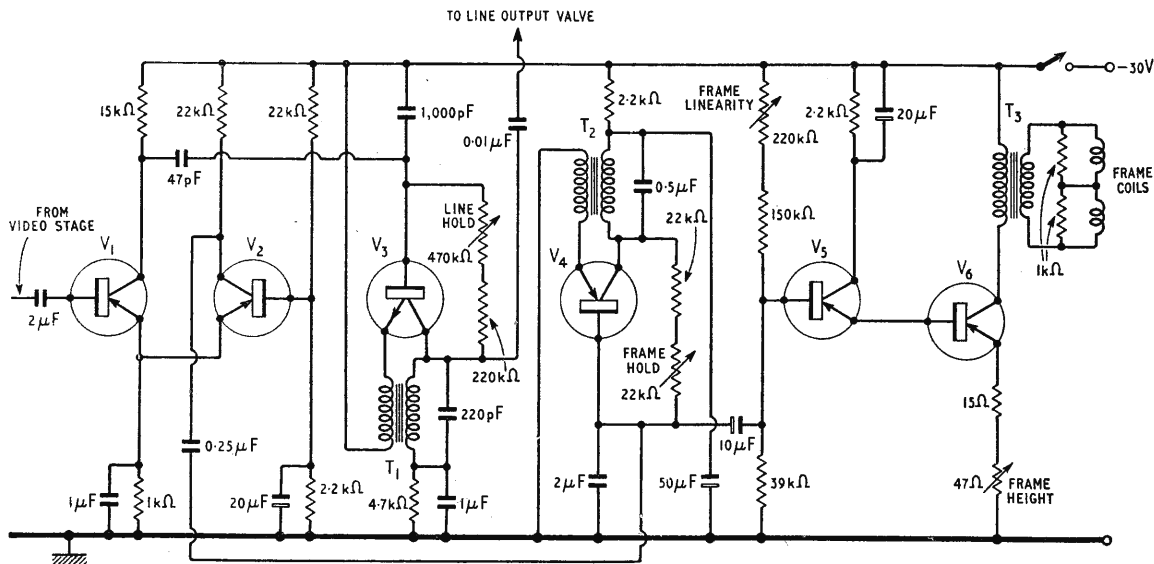

Fig. 1. Transistorized section of television receiver shown by G.E.C. Note the use of an n-p-n transistor for V3

AUDIO FAIR

List of Exhibitors

WITH one or two exceptions all the exhibitors (see below) at the Audio Fair (April 12th-15th) will have demonstration rooms as well as stands in the main hall of the Waldorf Hotel, Aldwych, London, W.C.2. The Fair is open daily from 11 to 9.

Tickets for individual days are available from the editorial office of *Wireless World*. Applications must be accompanied by a stamped addressed envelope.

Acoustical	Mullard
Armstrong	Pamphonic
Beam-Echo	Pilot
Brenell Engineering	Philips
Champion	Plessey
Chapman (Reproducers)	Pye
Collaro	R.C.A. Gt. Britain
Cosmocord	R.G.D.
Decca	Reslosound
Dulci	Rogers Development
Dynatron	Rola Celestion
E.M.I.	Simon
Electric Audio Reproducers	Sound Sales
G.E.C.	Specto
Garrard	Sugden
Goldring	Tannoy
Goodmans	<i>The Gramophone</i>
<i>Gramophone Record Review</i>	Trix Electrical
Gramplan	Thermionic Products
Grundig	Truvox
H.M.V.	Vitavox
<i>Hi-Fi News</i>	Vortexion
Leak, H. J.	Wharfedale
Lowther	Whiteley
Lustraphone	<i>Wireless World</i>
M.S.S.	Wright and Weaire

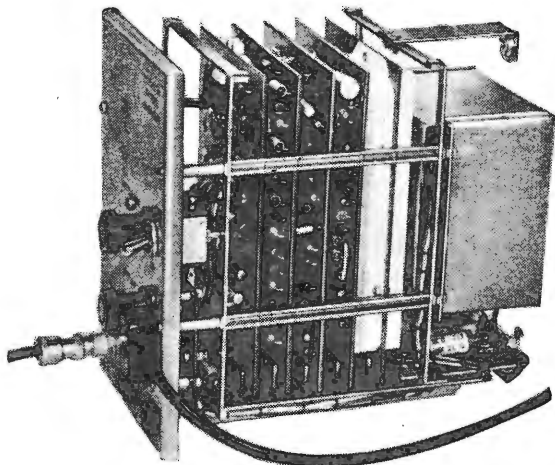

Fig. 2. Five printed-circuit boards are used in the Ferguson transistorized pattern generator, which measures only 7½ in x 6¾ in x 4¼ in

in the oscillator coil. A multivibrator using two OC71 transistors provides the basic waveform for synchronizing the external oscilloscope and the triangular waveform generator (which also has two OC71s). The sweep waveform is then amplified in a push-pull stage using two OC72s, which feeds an energizing coil wound on a ferrite rod. This particular unit works from a 4.5-V torch battery, drawing a total current of 110 mA.

Another test instrument, but for testing the transistors themselves, was shown by Mullard. This enables measurements of α and I_{co} to be made and gives an indication of collector turnover voltage over wide ranges of collector current and voltage. Details have already been given in our February, 1957, issue, page 80.

A good many of the operations performed in television circuits are essentially switching operations, and Ediswan were demonstrating the typical behaviour of the transistor in this type of work (for which it was originally developed, of course). By means of a pulse generator, an oscilloscope and several transistors of different cut-off frequencies, it was shown that the ultimate transient response depends on f_{α} and on the magnitude and direction of the current input. Storage of current carriers in the base region limits the speed at which a transistor switching circuit can be turned off, and if the transistor is driven into collector-current saturation in order to improve the rise time, this delay in turning off is prolonged. Best results were, of course, obtained with an r.f. transistor of high cut-off frequency.

A bibliography, covering published and some unpublished material, on printed circuits and allied techniques has been issued by the Television Society. It contains 468 references—classified and cross referenced—with an author index. The Society has also issued a second supplement to the bibliography of colour television published in 1954. It covers material published up to last August. Both bibliographies were prepared by Mrs. K. Bourton, Librarian at Ultra Electric, and cost 2s 6d each.

Awards to Technical Writers

AS reported in last month's issue, the Radio Industry Council has awarded five 25-guinea technical writing premiums for 1956. The scheme, which is to be continued for the present year, aims at encouraging members of the industry and others to write more freely about their work; it is described in a leaflet obtainable from the Council. The 1956 premiums were presented at a luncheon in London on March 14th. In the photograph, F. S. Mockford (Chairman, Radio Communication and Electronic Engineering Association) is seen presenting premiums to F. H. Brittain (centre) and D. M. Leakey (left).

Working in collaboration, they wrote the article "Two-Channel Stereophonic Sound Systems," published in *Wireless World* for May and July, 1956. Both authors are in the General Electric Company's Research Laboratories at Wembley.



WORLD OF WIRELESS

Organizational, Personal and Industrial Notes and News

Components Progress

A SIX-FOLD increase in the production of components during the past ten years is recorded in the 24th annual report of the Radio and Electronic Component Manufacturers' Federation. During the same period the volume of exports has increased over seven times and the value considerably more. The demand for components by the domestic receiver industry, which at one time during the period absorbed about 60%, has gradually decreased. It now takes only 40% of the output.

Although, as will be seen from the table, the domestic receiver field still absorbs more components than any other section of the industry, the value of those used in capital equipment is higher.

	Value (£M)	Quantity (M)
Domestic receivers	21.5	600
Capital equipment	25.0	450
Direct exports	16.0	275
Sound reproducing gear	6.0	100
Retail sales	10.5	} 75
Other	2.0	
	81.0	1,500

The 1956/57 report, which opens with a lengthy review of the country's industrial position in general and the radio industry in particular, provides a very full survey of trends—both technical and economic—in the components industry.

The Federation, which has so successfully organized its own exhibition during the past years, stresses that the question of exhibition policy is one for the whole industry—"there is no exhibition at present which is representative of the industry as a whole." Although during the current year there will be at least ten shows representing various interests in the radio and electronics field "not one major exhibition can justifiably be regarded as demonstrating the full magnitude, or as upholding the true prestige, of the industry."

Oscillator Radiation Limits

AN improved method of measuring oscillator radiation from television and v.h.f. sound receivers, evolved by the International Electrotechnical Commission, has been adopted by B.R.E.M.A. in place of the method put forward in 1954. At the same time the permissible limits of radiation in microvolts/metre have been reviewed and new recommendations have been made for frequencies between 30 and 250 Mc/s.

The total free-space radiation is measured at 3 metres by a comparatively simple procedure, using apparatus which can, for example, be set up on a flat roof. The method and the limits (which are also applicable to radiation at i.f. harmonic frequencies) will probably be incorporated in a revised version of BS905 due out later this year. Meanwhile, details can be obtained from B.R.E.M.A. at 59, Russell Square, London, W.C.1.

Servicing Technicians' Association?

WHEN the Radio Trades Examination Board was formed in 1942 the stated aim was "the promotion of a high standard of skill and efficiency in the technique and work of persons employed or otherwise engaged as radio mechanics, technicians and tradesmen in the radio and allied trades." Having established a sound basis for the certification of technicians and craftsmen in the domestic sound and television field, the Board has considered the desirability of extending its work into "the growing field of electronic application."

Suggestions have been made that the Board, which comprises representatives of the R.I.C., Brit.I.R.E., R.T.R.A., and Scottish Radio Retailers' Association, might encourage the formation of an association to provide, if required, the means of introducing candidates to prospective employers and to arrange meetings to enable successful candidates to keep abreast of new techniques in servicing and maintenance. The possibilities are, in fact, being examined.

International Recording Contest

TWO entries from England won awards in the recent Fifth International Recording Contest for the best amateur sound recording judged in Paris. G. Holmes Tolley, of Evesham, Worcs., won the first prize of 250 Swiss francs (presented by Radio Basle, Switzerland) in the Actuality Category with his recording of a Rumanian Folk Dance. The recording was made during the 1956 Annual Festival of Dancing at Stratford-on-Avon. The equipment used was an E.M.I. midget battery-operated tape recorder with a Lustraphone baton-type moving-coil microphone. The second award for a U.K. entry was in the same category and was won by Leslie Murray.

Over 400 entries were received, of which 115 were from France, with other entries from Denmark, Belgium, Germany, Spain, Austria, Chile, Holland and a few from Great Britain. Until last year's contest no entries at all had been received from amateur recordists in this country.

"Trader Year Book"

CONDENSED specifications of over 250 current commercial television receivers and all the 1956/7 sound receivers, lists of television and sound i.f.s, diagrams of base connections of over 300 valves, and directories of trade names and addresses are among the features included in the 1957 edition of the "Wireless and Electrical Trader Year Book." The value of the Year Book, which is now established as the *vade mecum* of the radio engineer, technician and trader, has been considerably increased by separating the radio matter from the electrical information. It costs 12s 6d.

PERSONALITIES

As already announced **Professor Balthazar van der Pol**, D.Phys., retired at the end of the year from the position of director of the International Radio Consultative Committee (C.C.I.R.), which he had held since its formation in 1948. Dr. van der Pol, who was born in Utrecht in 1889, spent three years in this country during the first world war, studying under Fleming at London University, and J. J. Thomson at Cambridge. From 1922 until his appointment with the C.C.I.R. he was director of research at Philips, Eindhoven. In a tribute to his work in international fields, the *Journal* of the International Telecommunication Union emphasizes that "as a man of science he could conceive of no frontiers . . . as an international official he systematically overlooked the nationality of the technical experts he had occasion to meet and treated them exclusively as scientists and engineers with whom ideas and information could be exchanged." In 1952 he was awarded the Valdemar Poulsen gold medal by the Danish Academy of Technical Sciences for his theoretical and practical work on the propagation of radio waves.

Sir Robert Kenwick, Bt., K.B.E., has resigned from the presidency of the Radio and Electronic Component Manufacturers' Federation to which he was appointed in 1947, and is succeeded by **Major L. H. Peter, A.F.C., M.C., M.I.E.E.** Sir Robert, who is a director of a number of companies, including Associated Electrical Industries, was controller of communications equipment at the Ministry of Aircraft Production during the war. He has been president of the Radar Association since 1955. Major Peter is chief development engineer of Westinghouse Brake & Signal Company.

F. Langford-Smith, B.Sc., B.E., well known as editor of "Radio Designers' Handbook," has left his native Australia, and has joined the English Electric Valve Company, Chelmsford, as editor in charge of its technical publications. He had been with Amalgamated Wireless (Australasia) since 1932 and was for some time engineer in charge of the company's valve laboratory. Mr. Langford-Smith, who graduated at Sydney University, was in this country from 1928 to 1932, initially with Metro-Vick, and subsequently as valve development engineer with Cosmos lamp works.

Dudley Saward, O.B.E., has been appointed managing director of Texas Instruments, Ltd., the recently formed U.K. subsidiary of the U.S. organization Texas Instruments, Inc. New works and offices are being erected for the British Company in Kempston Road, Bedford. Mr. Saward was chief radar officer to the Commander-in-Chief, R.A.F. Bomber Command, during part of the war, and was appointed O.B.E. for his part in the development and application of radar navigational and blind bombing devices. He was for some time after the war controller of navigation and telecommunications for British European Airways. He is 44.

Two new posts have been created in Marconi's aeronautical division. That of deputy chief air radio engineer (development) will be filled by **G. P. Parker, A.M.I.E.E.**, and that of deputy chief air radio engineer (projects) by **J. H. Gill**. Mr. Parker will be responsible for the airborne and ground development group of the division, and Mr. Gill for airborne and ground installation projects. Both will be responsible to Dr. B. J. O'Kane, the company's chief air radio engineer.

R. D. Phillips, technical manager at 20th Century Electronics until 1952, when he went to Ferranti's on colour television tube research, has rejoined the company as senior engineer in charge of prototype development and production engineering of cathode-ray tubes.

R. J. Hayes, M.B.E., has joined Piezo, Ltd., of 26, St. Albans Road, Watford, Herts, manufacturers of quartz crystals. He has retired from the Board of Trade where he was for many years a senior executive in the Export Promotion Department.

W. O. P. Jones, B.Sc.(Eng.), A.M.I.E.E., recently appointed assistant superintendent of the Electronics Department of the Metropolitan-Vickers Electrical Company, has been manufacturing engineer in the department since 1953. He joined the company as a college apprentice in 1939.

O. H. Davie, M.I.E.E., who has been with Cossor for the past 18 years, has been appointed to the board of Cossor Instruments, Ltd., as technical director. He contributed to the development of the original Cossor double-beam oscilloscope.

OUR AUTHORS

Dr. Colin Cherry, reader in telecommunications at Imperial College, is engaged in research in experimental psychology in communications, and in an article on page 164 discusses the importance of this subject in telecommunication engineering. Dr. Cherry, who graduated at the Northampton Polytechnic in 1936 whilst a research student at the G.E.C. Research Laboratories, later joined the Laboratories' scientific staff and during the war was attached to T.R.E. for radar research. He joined the staff of Imperial College in 1947, and was appointed to his present position as Henry Mark Pease reader in telecommunications in 1949.

R. F. Hansford, joint author of the article on the choice of wavelengths for radar in this issue, studied communication engineering at the Portsmouth Municipal College and during the war was at the Admiralty Signal and Radar Establishment developing navigational radar gear. After the war he was in the research department of the Sperry Gyroscope Co., and while there was responsible for the design and installation of the pioneering harbour radar at Liverpool. In 1952 he joined Decca Radar, to take charge of its newly formed radar applications division. He is a founder member of the Institute of Navigation and was for a number of years its technical secretary. His co-author, **R. Collis**, was a meteorologist in the Royal Navy before joining Decca as a meteorological specialist.



Dr. H. R. L. Lamont, contributor of "Colour TV on Tape," is European Technical Representative for the Radio Corporation of America, which he joined in 1953. A graduate of Glasgow University, he was on the staff of the G.E.C. Research Laboratories at Wembley from 1939 to 1950, engaged in research on microwave tubes and circuits and on propagation of centimetre and millimetre waves. Prior to joining R.C.A. he was for three years at the Royal Technical College, Glasgow, as senior lecturer in electronics.

Captain F. J. Wylie was among the delegates to the recent Maritime V.H.F. Radiotelephone Conference at The Hague, and he reviews the findings in an article in this issue. He attended the Conference as director of the Radio Advisory Service (Chamber of Shipping and Liverpool Steam Ship Owners' Association), which he founded a year after his retirement from the Royal Navy in 1947. Throughout his naval career he was closely associated with wireless, having successively been fleet wireless officer (Mediterranean), officer-in-charge of wireless experimental department of H.M. Signal School, deputy director signal department, Admiralty, and director of radio equipment, Admiralty. Captain Wylie edited "The Use of Radar at Sea" published by the Institute of Navigation in 1952.

W. Ian Heath, who, with G. R. Woodville, gives design data for a 50-watt amplifier in this issue, joined the Research Laboratories of the G.E.C. in 1939, and until 1946 was concerned with valve circuitry. He is now working with F. H. Brittain in the acoustics section of the Laboratories. **G. R. Woodville** joined the technical staff of the M-O Valve Company in 1935, after service with several other firms in the industry. He has been principally concerned with circuit applications of valves.

B. G. Martindill, author of the article on variable attenuators, joined Wolsey Television, of which he is general manager and chief designer, in 1950. For the previous five years he had been in charge of meter production with Automatic Coil Winder and Electrical Equipment Company.

John R. Greenwood, who in an article in the last issue described a method of indicating sound and picture intensities on a single cathode-ray tube, graduated in electrical engineering in 1951 at Leeds University. After completing National Service in the signals branch of the R.A.F. he was with the Bristol Aeroplane Company for a short while, working on the development of electronic measuring instruments. In 1954 he joined the B.B.C. and after gaining practical experience in sound studio engineering transferred to the Engineering Training Department.

IN BRIEF

January's increase of 187,088 brought the total number of **television licences** in the United Kingdom to 6,757,185. The number of domestic sound licences at the end of the month was 7,405,273 and those for car radio 303,318. There were, therefore, 14,465,776 broadcast receiving licences current in the United Kingdom at the end of January.

Some thirty papers are being presented at the "**Electronics in Automation**" Convention to be held by the British Institution of Radio Engineers at Cambridge University from June 27th to July 1st. The six sections will cover office machinery and information processing, machine tool control, chemical and other processes, simulators, automation in the electronics industry, and automatic measurement and inspection. During the convention the third Clerk Maxwell Memorial Lecture will be delivered by Professor Sir Lawrence Bragg. He will speak on the diffraction of short electro-magnetic waves.

Scottish I.T.A.—Since March 1st test transmissions with an effective radiated power of 1kW have been radiated from a pilot transmitter on the site of the I.T.A. station at Black Hill, Lanarks., between Airdrie and Bathgate. The station is operating in Channel 10 (vision 199.75 Mc/s, sound 196.25 Mc/s) on which the permanent station will begin operation on August 31st. The transmissions are vertically polarized.

For the ninth successive year the London and Home Counties Regional Advisory Council for higher technological education has prepared a **summary of applied research** in electrical engineering (including radio and electronics) in progress in university colleges and technical colleges in the region. The list, copies of which are available from the Council at Tavistock House South, Tavistock Square, London, W.C.1, is issued in the hope of stimulating industrial interest in the research being undertaken in the colleges.

Price Reduction.—Due to reductions in the world price of elemental selenium and to improved manufacturing methods employed by Standard Telephones and Cables, they have been able to reduce the selling price of SenTerCel spindle-mounted rectifiers by as much as 25 per cent.

A **private exhibition** of r.f. miniature cables and connectors is being held by Transradio, Ltd., at the Washington Hotel, Curzon Street, London, W.1, from April 8th to 11th.

Our publishers have issued the 6th edition of "**Television Explained**" which, within its 184 pages gives a non-mathematical presentation of technical information on domestic receiving equipment. W. E. Miller, the original author, was unable to undertake the extensive revision required, and E. A. W. Spreadbury, associate editor of *Wireless and Electrical Trader*, has undertaken the task. Several chapters have been rewritten, and a number of new chapters added to bring the book into line with modern television practice. The price is 12s 6d.

Facsimile Weather Charts.—Muirhead Mufax chart recorder, described in our April, 1954 issue, is being exhibited at the Science Museum, South Kensington, for the next few months. It can be seen in operation during the daily transmissions of weather charts from the Dunstable meteorological station at 12.10 and 16.50.

A new science film **Mirror in the Sky**, presented by Mullard, Ltd. and the Educational Foundation for Visual Aids gives an account of the work of Sir Edward Appleton on the ionosphere. It is intended both to excite the interest of the young with a view to encouraging them to take up a scientific career and as an instructional film for those already specializing in science.

British National Radio School, which moved to Bristol during the war, has returned to its original premises at 66, Addiscombe Road, Croydon, Surrey. (Tel.: Addiscombe 3341).

An evening **refresher course** for radio and television technicians is being arranged for the summer term (May 1st to July 3rd) at the Wesley Institute, Wesley Road, Stonebridge, London, N.W.10. (Fee 10s.)

FROM ABROAD

An international symposium on the **Physical Problems of Colour Television** will be held in Paris from July 2nd to 6th under the sponsorship of the International Union of Pure and Applied Physics, the Société Française des Radioélectriciens, and the Société Française des Ingénieurs et Techniciens du Vide. The discussions will come under four main headings: properties and behaviour of the human eye in colour television; image analysis and restitution; assessment and measurement of picture quality; and coding procedures for transmission of colour signals. Particulars are obtainable from the secretary, Colloque International sur les Problèmes de la Télévision en Couleurs, Conservatoire National des Arts et Métiers, 292, rue Saint-Martin, Paris 3e.

We have received from Fairchild Publications, of New York, a copy of "**Electronic News**," a weekly newspaper devoted exclusively to the electronics industry. Specimen copies of the 24-page paper, which covers technical and commercial matters throughout the world, are obtainable from the London branch of the publishers, 16, Berkeley Street, London, W.1.

Technical Co-operation.—At the invitation of the Finnish broadcasting organization an informal meeting was held in Helsinki in February between representatives of the International Broadcasting Organization (O.I.R.), which has its technical centre in Prague, and the European Broadcasting Union (E.B.U.), which has its technical centre in Brussels. The object of the meeting was to discuss the possibilities of extending the technical co-operation between the two organizations.



MEMORIAL STAMP for the centenary of the birth of Heinrich Hertz (February 22nd, 1857) issued in one denomination, 10 Pf., by the German Post Office. It will be on sale until the end of August.

BUSINESS NOTES

The **Hartley Baird** group of companies—which includes the manufacturers of Baird and Ambassador domestic receivers and tape recorders, Hartley Electromotives whose products include magnetic recorders, Duratube & Wire, Tenaplas, and three electrical appliance companies—has been acquired by Camp Bird, Ltd. They already control a number of other electrical and electronics companies, including E-V, Ltd., manufacturers of gramophone styli, and Hampton & Sons, radio and electrical retailers.

20th Century Electronics, Ltd., have signed a five-year agreement with Compagnie Générale de Télégraphie Sans Fil, under which the French company will use designs and patents of 20th Century. Similar licensing agreements have been signed with companies in the Netherlands, Belgium, Germany and Switzerland, the main interest being in multi-gun cathode-ray tubes and gieger tubes.

Decca Navigator Company, Ltd., has acquired the rights for the United Kingdom and certain other countries of the electronic self-steering device for ships—the Arkas Automatic Pilot.

A portable oscilloscope and recording oscillographs (including a portable model) made by **Siemens & Halske**, of Germany, are distributed in this country by W. Wykeham & Co., 17-19, Cockspur Street, London, S.W.1. A number of radio components, including small tubular tantalum electrolytic capacitors, made by the Siemens-Halske organization, are marketed in this country by R. H. Cole (Overseas), Ltd., 2, Caxton Street, Westminster, London, S.W.1.

A recent order for twenty **Marconi** radio compasses brings the total to over 600 which the company has installed in Vickers Viscount aircraft. These automatic direction finders (Type AD.7092) are generally installed in duplicate.

V.H.F. radio-telephone equipment has been installed by **Marconi's** at the Wath-on-Dearne shunting yard in the eastern region of British Railways. Each of the five diesel engines is fitted with a 3-5-watt set, and 5-watt transmitter/receivers are installed in the two signal boxes.

Marconi Marine announce that they supplied or received orders for radio equipment for 35 of the 39 trawlers built in United Kingdom yards during 1956 for British owners.

Decca airfield control radar (Type 424), which provides both talk-down facilities and airport supervision in one unit, has been ordered by Skyways, Ltd., for installation at Lympne Airport, Kent.

All the television equipment for the I.T.A. studios in Glasgow and a complete three-camera television O.B. unit are being supplied by **Pye**. The studio equipment includes four cameras and ancillary control equipment, three film scanners and twenty-one monitors.

Orders for over 40 radio-telephone transmitter-receivers (Type AM104) have been received from the Flintshire and Norwich County Councils by **Hudson Electronic Devices, Ltd.** The AM104 is an amplitude modulated 15-watt set.

With the opening of its new factory at Lawrence House, Breakspear Road, Ruislip, Middlesex, the **Electronic Production Company** has increased manufacturing capacity, its specialities being coil winding, eye-letting, sub-assemblies and the manufacture of interference suppressors.

Closed-circuit television equipment, including Nera large screen monitors (48-in by 36-in), is available on hire from **P.A.M., Ltd.**, Meroo Siding, Guildford, Surrey.

Panda Radio Company, of Castleton, Nr. Rochdale, have opened a London showroom and office at Autavia House, Redcliffe Gardens, Kensington, S.W.10. (Tel.: Flaxman 0906.) G. R. Hamilton-Walker (G3LND) is in charge.

The industrial division of **Amplivox, Ltd.**, is being enlarged and the company has appointed R. Steven, B.Sc., as manager. He was formerly sales manager of Painton & Co.

OVERSEAS TRADE

January Exports.—After breaking records in 1956 with exports worth more than £40M (a 20% increase on the previous year), overseas sales of British radio and electronic equipment in January were over £3.2M—nearly 10% more than in January last year.

Poznan Fair.—At the time of going to press eight radio and electronics firms had taken space in the British section of the International Trade Fair being held in Poznan, Poland, from June 9th to 23rd. They are Acoustical Mfg., Cinema Television, Kelvin-Hughes, Marconi's, Pye, Redifon, Siemens-Ediswan and Solartron. Other manufacturers may wish to avail themselves of the opportunity being given by the Board of Trade for literature to be available at the official enquiry stand. Literature, which should be in Polish, must be sent direct to United Kingdom Official Trade Enquiry Stand, British Section, Trade Fair, Poznan, Poland, to arrive about June 1st.

S.R.E. for India.—A combined speech reinforcement and bi-lingual interpretation system has been installed by Tannoy in the Upper and Lower Legislative Chambers of the Government of Mysore, in Bangalore, India. In all about 170 microphones and a similar number of low-intensity speakers are installed. Headphones are provided for the interpretation system. A main control panel, similar to those in the Houses of Parliament, Westminster, is provided.

A quarter-million pounds' worth of radio and television equipment—from transistors to transmitters—was shown by Pye at the recent Leipzig Fair.

A variety of equipment, including transmitters, receivers, direction finders and frequency measuring gear, is required for a **monitoring station** in Burma. Manufacturers interested in the enquiry can obtain a list of equipment required from the Special Register Information Service, B.o.T., Lacon House, Theobalds Road, London, W.C.1. (Ref. ESB/3902/57.)

Recording Equipment.—Miles Reproducer Co., Inc., of 812, Broadway, New York 3, who manufacture a portable recorder, microphones and amplifiers, are seeking U.K. supplies of components and accessories. A representative will be visiting this country in a few months, and interested firms are advised to write direct to J. M. Kuhlik at the above address.

Frequency-modulated v.h.f. **radio-telephone equipment** is being supplied by Automatic Telephone & Electric Company to the five transatlantic liners operated by the Holland-America line, and for installation at the Hook of Holland. It is understood that a chain of coastal v.h.f. stations is being planned by the Netherlands Government.

A complete **television station** for operation in Band III on Eastern European standards—625 lines with a vision bandwidth of 6 Mc/s—has been ordered from Marconi's by the Polish broadcasting authority. The station, which will be built at Katowice, will be equipped with two 7.5-kW vision transmitters, two 2-kW sound transmitters and two combining units each feeding the outputs of a vision and sound transmitter to half the 16-stack aerial. The vision e.r.p. will be of the order of 200 kW. Studio equipment, film scanners and test gear is also being supplied.

Design for a 50-WATT AMPLIFIER

THE NEW G.E.C. "88-50" USING KT88 OUTPUT VALVES

By W. IAN HEATH*, B.Sc.(Eng.), and G. R. WOODVILLE†

FOR many years the KT66 valve has been regarded by many as the hall-mark of a high-quality amplifier whether "home made" or commercially manufactured. With a total anode-plus-screen dissipation of 28 watts, when operated with cathode bias, its power output, in push-pull pairs, ranges from the 12 watts of the original "Williamson" amplifier, to 32 watts when used in an "ultra-linear" output stage.

The new KT88 is a pentode with a higher anode-plus-screen dissipation of 40 watts, and a higher mutual conductance of 11 mA/V. With this valve it is therefore possible to build amplifiers having higher power outputs suitable for public-address equipment and high-quality sound reproduction in general. Due to the lower anode impedance of the new valve, its higher power output is obtained without increasing the h.t. voltage requirements beyond the limits of normally available components. For example if plugged into a KT66 "ultra-linear" output stage giving 32 watts, a pair of the new KT88 valves will give 40 watts with a corresponding increase in drive voltage. Thirty watts output is obtainable with a h.t. line voltage of only 375 volts, instead of 425 volts for the KT66.

The maximum power obtainable from a pair of KT88s with cathode bias is slightly over 50 watts with a h.t. line voltage of 500 volts. This article gives details of the design and construction of a 50-watt power amplifier using KT88s. A new pre-amplifier suitable for use with this amplifier will be described later.

The two units have been designed to offer an improved performance and range of controls compared with previous designs, yet they include no complicated networks or unusual components, and are comparatively economical to construct. They will reproduce from radio tuner, any magnetic (or crystal) gramophone pickup, microphone, or direct from a magnetic tape replay head. A rotary switch selects the input circuit required and at the same time adjusts the sensitivity and frequency correction for tape or disc recordings. The pre-amplifier is separate from the power amplifier to which it is connected by a flexible cable; its controls are similar in function to those on the G.E.C. "912" amplifier, but the operation of the treble slope and "presence" controls has been improved, and a rumble filter is incorporated.

Power Amplifier.—The circuit of the power amplifier is shown in Fig. 1. It contains a pair of KT88s connected in an "ultra-linear" output stage, a push-pull low-impedance double-triode driver stage using a B329, and a high-gain B339 first stage incorporating phase splitting. Overall feedback of -22 dB is used, and the input sensitivity is about 0.5 V r.m.s. to give full output power. The 500-volt h.t. supply is provided by a U52, and the electrolytic smoothing condensers are protected by the use of a thermistor against excessive voltage during the warming-up period.

The "ultra-linear" connection for output tetrodes

* Research Laboratories of the General Electric Co., Ltd.
† The M.O. Valve Co., Ltd.

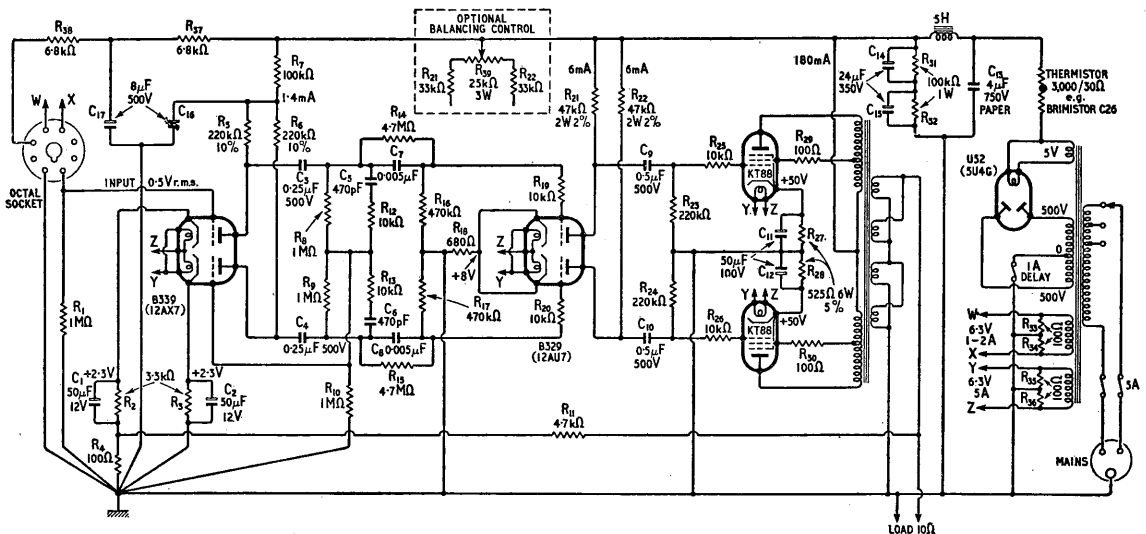

Fig. 1. Complete circuit diagram of main amplifier. Resistors are rated at 1/2 watt unless otherwise stated.

and pentodes has become popular during the past two years. As will be seen from Fig. 1, it resembles the triode connection except that the screen grids are tapped down the primary winding of the output transformer and the signal voltage on each screen is only 20 per cent to 40 per cent of the signal voltage in the corresponding anode†. Its advantages are that it gives a maximum power output at least equal to that obtained from the pentode connection, with distortion similar to or less than that for the triode connection, which gives less than half the power output. For equal power output, the distortion from an "ultra-linear" output stage is about half that for a triode stage using the same valves. The "ultra-linear" connection also provides a low output impedance, roughly equal to the load, and a good damping factor is, therefore, easily obtainable when feedback is applied. A push-pull output transformer is required which has each half primary tapped 40 per cent (turns ratio) from the h.t. end. Leakage and inductance requirements are discussed later.

The use of a push-pull pair of triodes for the driver stage was chosen so that the output stage would be symmetrically driven, and that no unbalanced operation would occur even at the onset of grid current in the output valves during overload. The removal of the phase splitter to an earlier stage ensures that the time constants in the grid circuits of the output valves are the same. The B329 is used in this stage because it has a low anode impedance, about 10,000 ohms. With this low value of driver impedance the phase shift due to the input capacity of the output stage is relegated to frequencies above 50 kc/s, and this, combined with the symmetry of the circuit, greatly assists in ensuring freedom from h.f. instability when feedback is applied overall.

A high-gain first stage (B339) is used to provide good balance in the phase-splitting circuit, and also adequate overall sensitivity after feedback is applied: the phase-splitter circuit used is one in which the input to the grid of the second or inverter triode is automatically balanced against its stage gain. This circuit gives a push-pull output from the two anodes of the B339, and as the amplifier is truly push-pull from this stage through to the output transformer little h.t. smoothing is required, with a corresponding economy in components.

Balancing Circuits.—The push-pull output from the B339 stage is balanced to about 2 per cent, a high-gain stage being an advantage here. This balance is improved slightly by the use of an un-bypassed common bias resistor in the cathode circuit of the B329 driven stage. This degree of balance is very satisfactory for many purposes, and with close-tolerance cathode bias resistors the KT88 valves used in designing the prototype amplifier have given a consistently symmetrical output voltage waveform when driven up to full power output when the peaks just show "flattening" due to the

onset of grid current. However, it has been found on amplifiers of this type with unmatched output valves that minimum distortion is obtained when the push-pull drive is adjusted so that both output valves reach the onset of grid current simultaneously as the drive voltage is increased.

Where facilities are available, and it is desired to make this adjustment, alteration of the balance of the push-pull drive is obtainable by relative adjustment of the two anode loads of the B329, and accordingly a pre-set variable wire-wound potentiometer R_{33} is shown in Fig. 1 incorporated as part of the anode loads circuit. The waveform of the voltage across the secondary of the output transformer can be observed on a cathode-ray oscilloscope connected across a dummy load resistance, and R_{33} should be adjusted so that with a sinusoidal

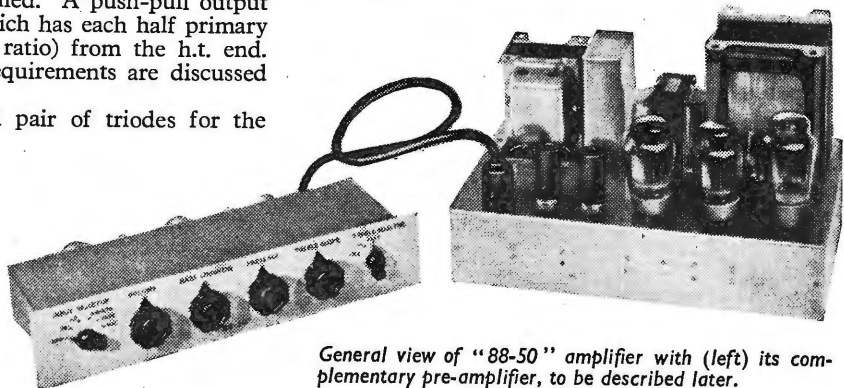

General view of "88-50" amplifier with (left) its complementary pre-amplifier, to be described later.

input voltage of suitable value the output waveform shows similar "flattening" on both positive and negative peaks. Although judged visually, this adjustment can be made with more than sufficient accuracy, provided the input waveform is free of second harmonic distortion. To avoid phase effects a frequency is chosen between 200 and 2,000 c/s.

Stabilizing Circuits.—When feedback is to be applied over an amplifier it is desirable that it is truly "negative" feedback over the whole frequency range that will be fed to the amplifier. At frequencies outside this range the feedback should be either "negative" or inoperative. If this is not so, the final frequency response of the amplifier will show peaks. Further increase of feedback, or in borderline cases certain types of input signal, will produce oscillation at these "peak" frequencies. Even if oscillation does not occur the amplifier will "ring" at these frequencies; that is, when an input signal containing the "peak" frequencies is interrupted the output from the amplifier will not cease as abruptly as the input, the "peak" frequencies persisting with a more gradually decaying amplitude. The "peak" frequencies usually occur at very low or very high frequencies, and are due to phase shifts in the intervalve coupling circuits and in the output transformer itself.

The low-frequency peak occurs only when feedback is applied, and is due to the combined phase shift of the intervalve coupling capacitors in conjunction with the associated grid leaks, together with the phase shift of the output transformer's primary inductance in conjunction with the load and valve impedances. The peak in amplification commonly occurs well below 20 c/s and often results in low-

† Either ratio is satisfactory, but with 40% screen tapings it is easier to design an output transformer giving freedom from instability at very high frequencies.

frequency instability ("motor-boating") when a pre-amplifier is connected to the same h.t. power supply. The effect is reduced if the several phase shifts are arranged to occur at differing frequencies, for example in the circuit of Fig. 1, large coupling capacitors are used so that phase shift due to them will occur at frequencies lower than that due to the output transformer.

Complete or nearly complete avoidance of a low-frequency peak can best be obtained by reducing the gain of the amplifier before feedback is applied at the frequency at which the peak is expected, without introducing additional phase shift at this frequency. If a flat frequency response is required down to this frequency, then the reduction in gain should approximately equal the feedback to be applied. This is achieved by inserting a small coupling condenser shunted by a high resistor, so that with the following grid leak the gain is reduced as the signal frequency is lowered until at the very low frequencies where a peak is expected the gain is reduced by a substantially resistive potential divider with very little phase shift. For a 20 dB (10:1) gain reduction the shunt resistance should be ten times the grid leak. The capacitor should be sufficiently small to have an impedance at the very low frequencies equal to or higher than the shunt resistance.

As the "88-50" amplifier is push-pull throughout such a circuit has to be incorporated on each side, and on one side, in Fig. 1, this consists of C_1 shunted by R_{14} and followed by grid leak R_{16} with C_2 , R_{15} and R_{17} on the other. The valves chosen will give low-frequency stability with any output transformer capable of delivering the full power output down to 40 c/s. An advantage of the inclusion of this type of stabilizing circuit is that there is no tendency for the amplifier to "motor-boat" when the pre-amplifier is connected to the same h.t. line. The smoothing used in the pre-amplifier supply is therefore economically chosen solely to give sufficient ripple reduction.

At the high frequencies peaks may be detected in the response of most amplifiers when this is measured up to 100 kc/s or 200 kc/s before feedback is applied. These peaks are due to resonances in the output transformer, the most important of which is the series resonance of the primary leakage inductance with the primary winding capacitance. This is commonly the cause of the "first" peak, i.e., of lowest frequency. The response usually shows a general downward trend, and this is due to the total shunt capacities, including Miller effect, across each anode load in the amplifier. When feedback is applied the combined phase shifts due to shunt capacities and leakage inductance cause the peaks in the response to be exaggerated, and often rise above the mid-frequency level.

With the output transformers used in designing the prototype "88-50" amplifier the leakage inductances between the several windings were low, as described later, and the "first" high-frequency peak was detected about 100 kc/s. Accordingly a stabilizing circuit, similar in principle to that used at the low frequencies, is incorporated. This consists of a shunt capacitor connected across the anode impedance of the first valve, with a series resistance to limit its shunting effect to about 20 dB (10:1) and minimize phase shift at frequencies above 50 kc/s. In Fig. 1 this circuit consists of C_3 with

R_{12} in series, and on the other side of the amplifier C_6 with R_{13} in series. These values are sufficient to give stability when the amplifier is loaded capacitively, and to reduce "ringing" on a square wave input (10 kc/s repetition rate) to only about 10 per cent overshoot on a resistive load, and even less on an inductive load.

The use of condensers for improving stability across any portion of the output transformer is not recommended in presence of the above stabilizing circuits, and was found merely to lower the resonant frequency, which was undesirable, and in some cases increased overshoot. The use of such condensers depends on individual transformer design, and is not suitable in this context. No reactances giving phase correction are included in the feedback network itself (R_{11} and R_4) because the correct choice of reactance is critically dependent on the type of load and output transformer used. For example overshoot, or actual instability, using a given transformer and dummy load resistance can be greatly reduced by shunting the feedback resistance R_{11} by a critically chosen value of capacitance, but this will be found to worsen stability on a reactive load such as a loudspeaker. This behaviour is common to all feedback amplifiers, and the stabilizing circuits here incorporated within the amplifier itself give satisfactory results with a wide variety of loads, and with the several transformers used in testing the prototype.

Greater stability could be obtained with inferior output transformers by altering the capacitances in the stabilizing circuits so that the level frequency response of the amplifier, before feedback is applied, is further restricted. The level frequency response at high and low frequencies will be restored when negative feedback is applied, but the amount of feedback (difference in gain with and without feedback) will be so reduced that the overall harmonic distortion at high and low frequencies will be considerably higher than at mid-frequencies. In addition the valve preceding the stabilizing circuits handles a higher signal voltage at high and low frequencies, and extra distortion may occur here as well as the distortion inherent in using a poorer output transformer.

The stabilizing circuits shown in Fig. 1 are incorporated in as early a stage as possible, so that only one valve precedes them within the feedback chain. The components' values have been found satisfactory for use with a typical "minimum" transformer, but are primarily intended for use with a transformer of the type described below. The reduction of feedback at 40 c/s and at 10 kc/s amounts to some 6 dB less than the -22 dB feedback at mid-frequencies.

Output Transformer.—The output transformer used for the first prototype amplifier was the type WO866, made by R. F. Gilson, Ltd. Although originally intended for operation with valves of lower power output, it gives a very good account of itself with the KT88 from 40 c/s to 20,000 c/s. Another transformer tried with excellent results was the Savage Type 4N1. For its extra size and cost this would deliver the "full power" output down to a lower frequency than the WO866.

The requirements for an "ultra-linear" transformer to be used with feedback are adequate primary inductance and low leakage inductances between primary and secondary (as normally connected), between each half primary, and between each half primary (anode-tapping) and the associated

screen tapping. The primary winding capacitance must also be low enough to relegate the lowest high-frequency resonance to the region where a reasonable stabilizing circuit has reduced the gain of the amplifier without appreciable phase shift.

Both the transformers mentioned gave measurements of all five leakage inductances less than 6 mH, and a high-frequency resonance in circuit operation above 100 kc/s. The WO866 achieves this by the use of gain-oriented silicon iron, with moderate sectionalization of the windings, and the 4N1 achieves similar figures with a larger core of normal silicon iron by more sectionalization of the windings.

Construction.—The accompanying photograph shows the underside of the power amplifier chassis. The prototype was constructed on a chassis measuring 14in × 9in × 3in. The mains transformer was of ordinary silicon iron, but the choke and output transformer were of grain-oriented silicon iron and were therefore comparatively small. A slightly larger chassis would be needed if larger transformers were used, but the same layout must be used, and the transformers positioned as in the top view of the amplifier. Because of the high h.t. voltages it is advisable to mount the transformers "tags down"; the elongated holes required can easily be cut with a valve hole-cutter and file.

The heater wiring should be laid in first, with twisted twin wires laid along the bend of the chassis. The valveholders are oriented to avoid the heater wires crossing the grid wiring. The second heater supply to the octal pre-amplifier socket connection should also be laid in. Both supplies must have a centre-tap earthed to chassis, or an artificial centre-tap using two equal resistances, as shown. An earth point should be chosen next the first valve B339, and a "star" tag bolted down with a serrated washer to

ensure good contact. This will be the one earth point to which all grid, anode, and intervalve coupling circuits must be connected by insulated wiring. The signal input (pin 8 on the octal socket) should be wired as directly as possible to the grid of the first valve; the earth (pin 1 on the octal) connected to the "star" earth tag, and the grid leak connected. The cathode bypass condenser with feedback resistance R_4 in series should be connected between the cathode pin and the "star" earth tag using the smallest total loop area of wiring possible, and keeping the cathode circuit as close to the grid input lead as possible. The cathode bypass condenser of the second half of the B339 should be wired in an equally compact fashion. The grid of this valve is fed from the phase-splitting network connected between the two anodes, and this should be wired as compactly as possible consistent with good mechanical location of the components.

The tagboard is used for all the smaller components, but the larger coupling condensers and the later cathode bypass condensers are mounted by standard clips on the side of the chassis. Except for C_{14} the clips "earth" the condenser cases, which thus provide screening. For ease of servicing almost no wiring is beneath the tagboard.

Wiring should be continued by working through the amplifier, keeping grid and anode wiring as short and as separated as possible, while "dead" wiring such as h.t. leads returning to a smoothing condenser, or cathode bias resistors which are bypassed, may be longer to "fit in." Stopper resistors R_{19} , R_{20} , R_{25} , R_{26} , R_{29} , and R_{30} are included to kill instability at radio frequencies, and must be wired closely on the valveholders with very short leads. "Stoppers" are unnecessary in the grids of the B339.

The earth connecting point associated with each

Underside of chassis showing layout of principal components.

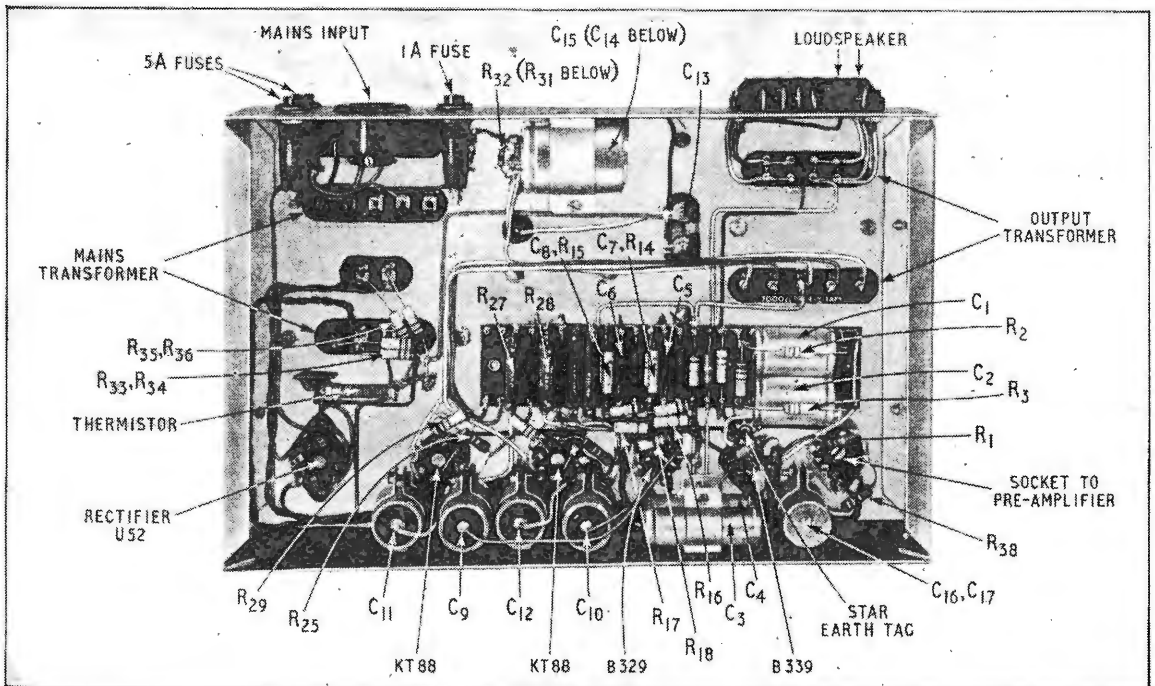

valve should be insulated, and connected back to the insulated earth point of the preceding valve, and so to the original "star" earth tag. The earthed side of the secondary of the output transformer should also be returned to this tag as this is part of the feedback circuit. An exception may be made of the h.t. supply earth, and the heater supply centre tap earths, which can be connected to any convenient points in the chassis.

The mains transformer is as remote as possible from the input to discourage hum, and its orientation should be noted. The output transformer is of necessity nearer the input, and the "live" anode and screen wiring to it should be bound together and laid carefully away from the tagboard and other components.

Using the precautions outlined above the "strip" layout of this amplifier gives the greatest separation of input and output and the least potential "teething troubles."

Connecting the Feedback.—When completed and checked, a dummy resistance load should be connected, and first switched on with the feedback disconnected by an open circuit at R_{11} . If the voltages measured across the cathode bias resistors approximate to those shown in Fig. 1 (some voltmeters will give a lower reading) a test signal may then be connected to the input of about 100 mV, and a loudspeaker tapped across the dummy load. If an audio oscillator is not available, a gramophone pickup having a high output, such as a crystal type, can be connected to the input via a temporary volume control. An extra resistance of about $47\text{ k}\Omega$ should be connected in series with R_{11} .

With the test signal audible, the feedback should be connected, and a note made of whether the output is increased or decreased. If the feedback increases the output the connections to the output transformer must be reversed. If the feedback

decreases the output then the connections are correct, and the feedback may be permanently connected with the extra resistance removed. This method removes the risk of oscillation and possible damage to the output valves and transformer.

Performance.—The maximum power output of an R-C coupled amplifier such as that described here may be conservatively defined as the maximum obtainable without driving the output valves to grid current. This criterion is easily checked on a cathode-ray oscilloscope, the onset of grid current being observed as peak clipping, the input being reduced just to avoid this. The measurements described below use this method of determining maximum power output.

Fig. 2 shows the maximum power output, measured across various values of dummy load resistance on the secondary of the WO866 transformer. An output of 50 watts is obtained in the load with an equivalent anode-to-anode load of 5,000 ohms, which corresponds with this transformer to a load resistance of 10.7 ohms. These conditions were used for subsequent tests.

It should be noted that values of anode-to-anode load below 4,000 ohms give increased distortion and are not recommended. The WO866 transformer has a ratio which gives a primary load of 7,000 ohms for a 15-ohm secondary load, and satisfactory operation can be obtained when operating into one 15-ohm loudspeaker giving about 40 watts maximum output, or into two 15-ohm loudspeakers connected in parallel giving about 60 watts at somewhat greater distortion. At frequencies above and below 500 c/s the impedance of a loudspeaker, or loudspeaker assembly, is usually greater than the nominal value, and the effective load is therefore higher.

Fig. 3 shows the frequency response at a power output of about 1 watt into a load of 10.7 ohms. The level response with the absence of peaks over the whole frequency range from 10 c/s to 100 kc/s indicates that the stabilizing circuits are very satisfactory with an output transformer having the characteristics described earlier. In consequence the amplifier is completely free of any tendency to parasitic oscillation under drive. The tendency for the response to fall below 10 c/s is typical of a stabilized amplifier with feedback, and greatly assists l.f. stability when a pre-amplifier is connected to the same h.t. supply.

Fig. 4 shows that maximum power output is obtainable within 0.5 dB over the audio band from 30 c/s to over 20 kc/s. Below 30 c/s this is limited by flux saturation phenomena in the output transformer, rather than by peak clipping in the output valves. At these low frequencies the power at which saturation occurs depends on the unbalanced d.c. in the transformer primary. This was 2 mA in the amplifier under test with unpicked valves. The power output is maintained to well above 20 kc/s

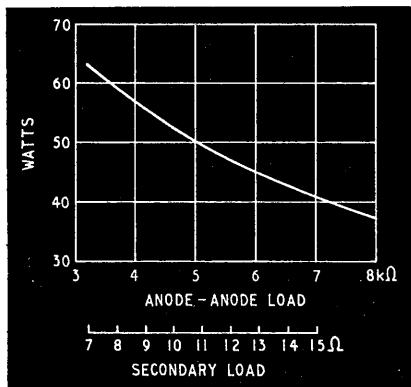

Fig. 2. Maximum power output of KT88 output stage delivered to load on secondary of transformer (Gilson WO866), at 500 c/s.

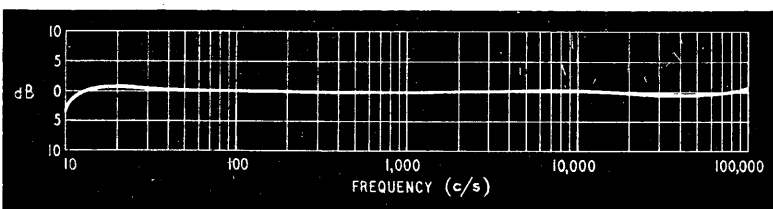

Fig. 3. Frequency response of power amplifier measured at 1 watt output.

because of the low leakage inductances and lack of resonances below 100 kc/s in the output transformer.

Fig. 4 also shows the distortion at maximum power, and this is less than 0.1% of the fundamental for both 2nd and 3rd harmonics at 500 c/s. The increases at 100 c/s and 5,000 c/s are due to the reduction of effective feedback at high and low frequencies because of the stabilizing circuits, but this is a small price to pay for the clean performance resulting from good stability. The harmonic distortion was measured up to 15 kc/s, and listening tests confirmed the merit of the results shown.

The maximum power output is obtained with an input drive of 0.5 volts r.m.s., and the hum level is -73 dB with the input open circuited, or better than -90 dB with the input short circuited. The feedback is -22 dB at 500 c/s with the components shown and a 10.7-ohm secondary (24 volts output). For use with load impedances other than this the feedback resistance R_{11} (4,700 ohms) should be

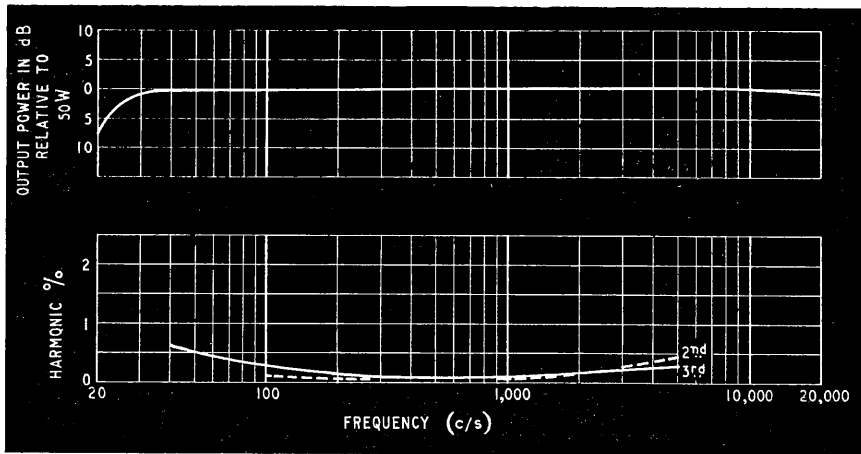

Fig. 4. Maximum available power at different frequencies, and distortion at maximum power output. Transformer: Gilson WO866. Load 10.7 ohms, equivalent to 5,000 ohms anode-anode.

altered in proportion to the resulting output voltage.

The authors wish to record their thanks to their colleague D. M. Leakey for his considerable help and advice during the design of this amplifier.

Useful References

"Stabilizing Feedback Amplifiers," Thomas Roddam, *Wireless World*, March, 1951.

"UL Output Transformers," D. M. Leakey and R. B. Gilson, *Wireless World*, Jan., 1956.

ITALIAN TELEVISION DEVELOPMENT

RAPID GROWTH OF THE NETWORK

WHEN the Italian broadcasting authority, Radiotelevisione Italiana, has completed its chain of 98 television stations in two or three months' time, Italy will have one station to every 1,220 square miles against the United States' one to 6,144.

At the end of December there were 24 main stations and 40 satellites, or relays, but by the end of June there will be three more main stations and a further 31 satellites, making 98 in all. When the chain is completed each station will serve an average of 480,000 people; in the United States the ratio of population to stations is 341,000 to one.

Despite the considerable growth of the network in the past twelve months the number of licensed receivers was only a little over 300,000 at the end of December—about 5,000 to each station then in use. In the country there is an average of 357,400 sets for each television station, and in the United States (where at the end of the year there were some 500 stations) about 84,600 per station.

As will be seen from the sketch map, radio links are provided between the main stations, but the satellites, which have transmitters rated at from 5 to 50 watts, rely on direct reception from a main transmitter for re-broadcasting. The majority of these satellites are unattended, are equipped with duplicate transmitters, and are automatically switched on and off by pre-set time switches. Many of them serve a comparatively small population in enclosed valleys.

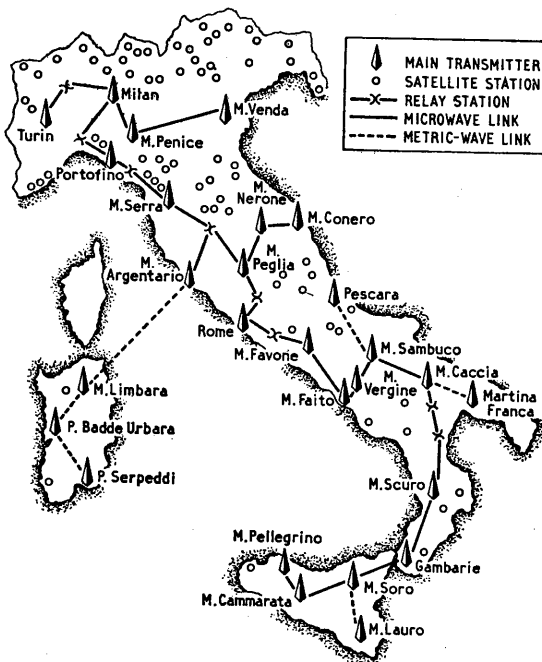

Radio links are provided between the main stations.

HEARING AND

Importance of Experimental Psychology in Telecommunications

IT has been traditional for the telecommunication engineer to concern himself, almost wholly, with the design of *equipment*; equipment to be used for transmitting, receiving and reproducing signals accurately. Most of his research has been directed to the preservation of waveforms accurately, and to the reduction of harmonic distortion, noise levels and cross-talk. To accomplish this, the telecommunication engineer has trespassed beyond the classical bounds of "try-it-and-see" engineering, as evolved so magnificently in the 19th century by men of great practical experience, and has steadily drawn more and more from the fields of mathematics, of classical physics and, in recent years with the coming of semi-conductor devices, of quantum physics too.

I use the word "trespass" here advisedly, for a sense of trespass is aroused only initially. But, once accepted, the trespassers become friends and the bounds and unity of a science grow. I hope that what I have to say may convince those of you already unpersuaded, that the latest science to be drawn into contact with telecommunications, to the betterment of both, is experimental psychology—especially the study of sense perception.

New Philosophy Needed

The idea that telecommunication systems should be designed solely on a basis of waveform purity preservation is historical; it arises from the particular practical needs and the theoretical tools available, as these have existed in the past. Faithful signal reproduction is not the basic purpose of a telecommunication system at all. A telecommunication system, by itself, does not communicate. People communicate, one with another. I would suggest that we take the following as a guide to the ultimate purpose of any telecommunication system, inasmuch as we need such guides or philosophies as long-term goals in our research: *the purpose of a telecommunication system is to transmit those data, or "clues," sufficient to set up in the mind of the recipient those illusions which are desired by the sender, under given environmental conditions.*

For the popular and descriptive term "illusions" here we may substitute "beliefs." For beliefs are all you have; all that the sensory side of your brain deals with are "beliefs." When awake you are continually in some state or other of belief, and communication signals, such as the printed characters on this page, continually operate upon your sensory nervous system and change your state of belief. But more of such philosophical points later.

As in the past, it is partly the practical needs of the time which are forcing us to take this wider view of telecommunication. And we see an analogous changing attitude in our sister-sciences and techniques, especially automatic control. The practical needs may be exemplified by: the accelerated developments of automation (with its increasing

supervisory tasks and sense-substitution devices); high-speed tracking as in flying jet aircraft (at such speeds and under such stress conditions that the pilot and aircraft become integrated into a unified bio-physical mechanism); and, within telecommunication pure, it is the urgency of increasing ether congestion, or finite message-capacity, which is forcing our attention more and more upon human perception and its mysteries—especially aural perception.

"Ether congestion" may suggest only work upon technical means of compressing the bandwidth of speech or music channels, or facsimile and television channels. Practical working systems have, of course, already been designed and made; for example, those of Gabor¹, or the "Vocoder"², or the parametric systems of Lawrence,³ or the G.P.O.,⁴ or the Haskens Laboratories in New York. But the details of the systems are of less interest in the present context than the way in which their development has opened our eyes wider and made us realize how little we know, as communication engineers, of how the brain carries out its tasks; of *how* and *why* these practical systems succeed in doing what they do. All these systems of channel compression have been evolved by an experimental philosophy, with a little guiding theory which has steadily grown to embrace some speculation or quasi-theory of the human receptor organs and nervous system. Theories of the ear are now so numerous and complex that Helmholtz would well be more peaceful in his grave. Not only the ear mechanics but the aural nervous system must be brought in.

Briefly, these attempts to compress bandwidths, or otherwise to reduce the redundancy of speech and vision channels, have shown us that the way to real success is blocked until we understand much more about human listening and seeing; but, more important, this work has singled out and highlighted a number of absolutely fundamental prob-

¹ I.E.E., Vol. 94, Part III, Nov., 1947.

² I.E.E., Vol. 95, Part III, Sept., 1948.

³ "The Synthesis of Speech from Signals Which Have a Low Information Rate," by W. Lawrence. In "Communication Theory," Ed. by Willis Jackson, Butterworths, 1953.

⁴ "Wireless World," June, 1956, p. 291.

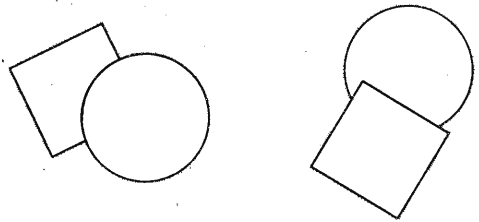

Fig. 1. "Gestalten." Looking at the two geometrical figures you "see," and respond to, a circle and a square. Yet neither figure is actually complete.

SEEING

By COLIN CHERRY,* D.Sc.

blems of human perception. These are a challenge to us, just as they are to the psychologist, but the particular way in which they have emerged in our own science has exposed a technique (that is, a body of apparatus and methods) which is being taken over by psychologists.

We have reached the stage now where first-class experimental psychologists are working with communication engineers, in complete mutual understanding and sympathy. On a long-term view this merger cannot fail to be a success, and I would stress that there will be great dividends to be had. Again on a long-term view not only will "band-compression" systems benefit but our approach and whole potential for tackling communication problems will be affected.

No Universal Criteria

It will be apparent to anyone who has heard various systems for compressing speech channel bandwidths that these systems have specialized uses. For instance, one system may be excellent for conveying the bare word or phrase content of spoken messages, for military and similar uses; another may convey good telephone speech, with emotional qualities, yet fail to satisfy the critically musical listener; one may operate well under one type of noise conditions, yet fail under others; other systems may be unintelligible to a novice yet clear as a bell to one who has been trained to their peculiar "accents."

One lesson we learn from channel compression studies is that universal criteria (for example, "waveform fidelity") cannot be applied. We must now include not only the listener, with his particular habits of listening—the stimulus/listener relationship—but the whole environmental conditions as well. Listening and viewing tests must be made and various criteria satisfied, such tests raising a whole field of difficulties because communication of, say, speech is not a single, simple activity but a whole hierarchy of activities. Speech can communicate *who* the speaker is, his emotional states, his phrases and the sets of meaningful associations they set up, and other distinct categories. Correspondingly we may need several criteria; we may do articulation and intelligibility tests using logotoms, "jabberwocky," or single meaningful words, or whole sentences; we may go higher and speak problems to be interpreted and solved by the listener; we may emulate Stanislavsky, the great Russian theatre-master, who made his pupils speak the one word "tonight" in one of fifty emotions to be identified by the listener. All these various categories of communication, and criteria of success, are distinct and each is relevant under different conditions of environment and different practical requirements of the channel. There is no universal standard; we must ask the *purpose* and *conditions* of the channel.

In my section at Imperial College, within the Department of Electrical Engineering, our research is mainly concerned with human perception, especially aural, and I am frequently asked how I justify this incursion into experimental psychology.

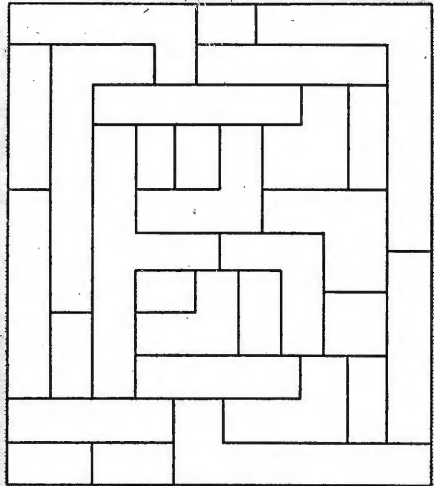

Fig. 2. A certain well-known sign is here buried in "noise." You may not spot it. But when you are told what it is, it "jumps out at you." (Answer on page 168.)

I hope now to have answered this question and I should like to proceed by saying something of the nature of human perception and of the fundamental problems which are of vital interest to the future of telecommunications.

We perceive only a minute fraction of all the sights and sounds around us; the rest pass us by. Only this fraction affects us and changes our state of belief; the rest leave us cold. Listening to a string quartet, one can perceive the whole music; or the cello alone; or the viola. This discriminatory faculty of the brain is a basic psychological concept. It is the perception of whole forms, or what are called, borrowing from the German, *gestalten* (see Fig. 1). What occupies my senses at any instant falls together into a whole pattern and excludes the rest. It forms the integrated patterned stimulus to which I respond. (In some situations the response is dependent on prior knowledge, as can be seen from Fig. 2.) How does the brain perform this selective operation? By what mechanism and logical basis?

One very special case which is directly relevant to telecommunication I have often called the "cocktail party problem." When in a noisy, crowded room I have little difficulty in singling out one speaker and listening attentively; yet my ears receive the conglomerated sound from 20 voices. The brain discriminates in a way utterly unlike the tuning or filtering action of a radio receiver and has no difficulty with its cross-talk problems. The *gestalt* is formed of one person's voice or another, as we choose. Regarded as a selective filter the brain can

* Imperial College, London. This article is based on an informal lecture given recently to the I.E.E. and has also been published in The Record of The Standard Radio Engineering Society.

act only statistically, making continual inductive inferences from the mass of acoustic data received, dependent upon its past experience, immediate and distant. That is to say, habits are called into play and these habits, of speech, of sight, of touch, are far more extensive, deeper and influential upon our beliefs and actions than most people realize. Our brains have astronomical stores of probabilities, of phonetic sequences, word and phrase sequences, of all the aural and visual patterns which make up each individual's model of the "outside" world. And we are slaves to this store of habits.

Many experiments illustrate this. Spelling errors are commonly unnoticed in proof-reading; again, we can guess 75 per cent of the words of common speech; seeing a man standing in front of a chair or table we nevertheless perceive the chair or table whole, not broken. The brain most readily accepts the familiar, and rejects the bizarre. Our "realities" and our nightmares differ only in their probabilities. The sane man has his world and the dipsomaniac his.

The American psychologist S. S. Stevens has said that "discrimination is the most fundamental act performable." Since information theory is based upon the concept of discrimination or selection of one sign from another in a set or alphabet, it would seem to have direct relevance to the psychology of perception. Indeed it has. Numerous measurements have been made of the rates at which discriminatory acts can be performed, that is, of the rates at which information can be taken in—using the words "information-rate" in their technical, exact sense, measurable in bits per second.* The interesting point is the small proportion of the total information received which is actually used. When listening to speech about 50,000 bits/sec impinge upon the ear; when reading a book the retina receives millions; yet perceptually we take in and respond to information at the rate of a few tens of bits/sec. Information theory enables us now to put precise figures to the results of psychological experiments upon the discriminatory activity of the brain, whereas previously the results were only descriptive.

The brain, then, as part of a communication channel, has a very low capacity, but requires an enormous supply of information in order that it can carry out its inductive inferences with low chance of error. But it is not only the *quantity* of information reaching the ears and eyes which matters but the particular form or representation provided by the stimulus. There is a "matching" problem, and better understanding of the perceptions will assist us to match the better.

Mental Pigeon-Holing

This brings me to another fundamental psychological point in telecommunication; the brain not only discriminates between patterns, as *gestalten*, but must first form these *gestalten*. This faculty is commonly illustrated by our ability to recognize noisy or distorted speech. Most people would say that when a speaker speaks he utters words; noisy and distorted perhaps, but nevertheless words, strung into phrases. But this is not the logic of the case. Speech is a stream of sound, not segmented into words; everybody, saying "the same thing," sets

forth a somewhat different stream of sound. There is no pure standard speech; all speech is, in this sense, distorted from a norm. But, just as no one has met "the average man," we have never heard words in their purity. "Words" exist only as pigeon-holes in the mind of the *listener* whose brain sorts out the sounds received and classifies them into these pigeon-holes. All *gestalten* are pigeon-holes in this sense; the sense data we receive are classified this way. But the various processes we call "learning" correspond to the creation of new pigeon-holes, for subsequent sorting acts or discrimination.

I should not like it to be thought, with this emphasis on the value of studying brain actions, that I am advocating the direct imitation of these processes in telecommunication or other electronic equipment. No, for the brain has its astronomical store of prior data which we cannot possibly hope to imitate. Rather, it is better to emphasize that with better understanding of perception and brain processes we may approach telecommunication in a new way and achieve better "matching" to the human terminal, by providing his senses with the data his brain requires, in specific noise or other environmental conditions. We may perhaps abstract those clues from the stream of speech which set up the illusion of "the words" and achieve channel capacity compression, or better discrimination against noise or cross-talk.

Adaptability of the Brain

But another point arises now, as a warning. Since we can recognize speech in all accents, in various noises or degrees of distortion, this may suggest that certain invariant parameters exist universally and that all we need to do is to define these, abstract them automatically and synthesize the "standard" speech at the receiver. Indeed, this is roughly what Lawrence's speech compression system does. He abstracts, automatically, data concerning vocal actions, voice cavity resonances, etc., and transmits these. But we must guard against generalizing too far, because there is no *a priori* reason for assuming that the brain is stimulated always by identical sets of data, or invariants, in all circumstances. The stimulating data and mode of perception may change as criteria are changed. For instance, once a stream of sound has been identified as speech, the mode of perception may alter, for then we form immediate associations with our own vocal tracts. Speaking and hearing speech, are very unified.

We must guard against the too mechanistic view of the brain as a "black box" with a fixed mechanism inside, operated by definite and settled parameters. Rather, its mechanism (or our model of it) may change from instant to instant depending upon degree of success, upon what has already been perceived, or other criteria—recognition of the sounds as speech sounds, identification of the language, identity of the speaker, of his emotional state, of his words and phrases, and of their semantic content . . . a multi-layered process, the various layers being mutually dependent. We should think of the brain-mechanism as being self-adjusting, self-optimizing, flexible, not constructed unalterably like an alarm clock. Again, the whole human organism is an integrated structure, and we cannot divorce the operation of any one of the senses from that of the

(Continued on page 167)

* For explanation see "Information Theory," *Wireless World*, Sept., 1952.

whole organism. What we can smell depends partly upon what we see. Seeing and hearing, too, are associated; for instance, a loudspeaker nearby or behind you, at an open-air function, or a cinema, will deceive you into believing that you hear the platform speaker, or cinema actor, making the utterance—the sound directions, physical and perceptual, are made to differ by the formation of this life-like *gestalt*.

My own researches have dealt far more with hearing than with seeing, and I should like particularly to refer to some of the fundamental facts about aural perception, whose understanding will, in my opinion, profoundly affect telecommunication in the future.

The basic problem, to me, is the one I have already called “the cocktail party” problem—how can the brain separate one voice from two or more falling concurrently upon his ears; how does the brain deal with its cross-talk problem? There are two particular aspects to this—with one-ear listening and with two-ear listening. Let us take the last-mentioned first.

We have two ears and yet we hear only one world. Normally, a binaural fusion takes place, but in a very subtle and valuable way. For the brain makes great use of the slight *difference* between the stimuli at the two ears; by virtue of this difference a listener may pull apart, in his subjective space, two simultaneous speakers so that *you*, Sir, appear to stand over there, and *you*, Madam, over there. This vital faculty is far from being fully understood and is almost wholly unexploited in telecommunications, as yet, even in so-called stereophonic systems.

Identifying Sound Directions

This “pulling apart” of two speakers, by the use of our two ears, greatly helps to solve the “cocktail party” problem. This faculty rests, *only in part*, upon the fact that two utterances, coming from different directions, stimulate the listener’s two ears with slightly different time intervals and intensities. These inter-aural differences alone are insufficient to identify precise directions; all they can do is locate the sources as lying in the right or left hemisphere, with certain probabilities. True directions are identified by using further evidence, in particular from what is termed the associated kinesthetic sense whilst turning the head, the use of previously learned properties of room acoustics and, possibly, the use of wave-front orientation of the sounds impinging on the ears. It is a most complex faculty and only partially understood. To most people, the hearing of other people’s speech is such a familiar experience that they cannot readily understand that there are such problems; how the sounds even get *outside* our heads, for instance (the so-called “projection problem”). Another example is familiar to musicians; two flutes playing together are heard outside the head, but the beat tone is heard inside.

It is no use saying here: Why, of course! The flutes “are” outside the head, but the beat is produced inside. If we wear headphones the sound invariably lies inside the head, but as the phones are drawn away from the ears the sound remains there; after some distance the sound comes out of the head and passes *behind*, never forwards.

One very simple experiment we have found to be most illuminating. In this, a listener sits on a re-

volving chair between two loudspeakers playing quite different long spoken messages; he is required to listen to one of these, and we observe his method. Invariably he turns until his two ears are in line with the two speakers—a symmetrical position. The sound from each speaker reaches the nearest ear first and, after about half a millisecond delay, the opposite ear. Simple algebra shows that one spoken message could be separated from the conglomerated sounds at the ears by subtraction of the two ears’ stimuli. Two ears give us this advantage over one.

Much more elaborate and lengthy experiments have shown us that the binaural process is not one of simple subtraction but one involving cross-correlation analysis* of the signals at the separate ears. I cannot discuss details sufficiently briefly here, but suffice it to say that this correlation analysis appears basic to the brain operation of spatially locating a sound and, in conjunction with other processes, of discriminating one voice from another as in the “cocktail party problem.”

Influence of Habits

Now you may have noticed one major difficulty, not yet discussed. Before a listener can separate two speakers, pulling them apart in subjective space, he must have the concept of *one* speaker or the other. Why should not two simultaneous speakers sound merely like some new experience—say like a single speaker, in a strange foreign tongue? How are the individual voice *gestalten* formed?

This is a fascinating problem; it essentially involves brain processes of a far higher order, partly at cortical and conscious level, and is independent of one-ear or two-ear considerations. Like other sensory-recognition, or *gestalt* formation, faculties, it depends upon our accumulated past experiences—in this case, past experiences of very, very many voices, in all accents and tones. From all this, we have accumulated a mental store, of astronomical scale, of phonetic and linguistic data—statistical data, that is—of sound and syllable probabilities, of sequence probabilities—a mass of data which represents “reality” to each of us. With this prior data, the brain may carry out continual inductive inferences about sounds falling on the ears. These inferences or guesses represent our own speech and hearing *habits*, which are so deeply ingrained into all of us.

A simple experiment illustrates the deep nature of these habits. If someone reads to me steadily out of a book, I have no difficulty in tracking on and speaking almost in synchronism with him, without seeing the book. His utterances readily stimulate my speech habits, and I am perceiving *and* uttering together, as a unified *gestalt*. On the other hand, if an English reader does this while an American listener responds, he responds in American, using words like *gotten*, *airplane*, *railroad*, these being his own cultural speech habits.

This question of past experience, of familiarity or strangeness of sounds, and of how the brain makes use of this prior data, greatly needs more study. It is basic to the understanding of how we recognize distorted speech, or speech buried in noise, or with cross-talk. If we understood more, we should be in a happier position to design communication

* For explanation of correlation techniques see “Recovering Hidden Signals,” *Wireless World*, March, 1955.

systems which could supply the listener with what his brain needs and so provide a better "match." Of course, individuals differ greatly in their past experiences, and have somewhat differing habits, whereas telephones and radio sets are for general use. Nevertheless, this can be treated as a statistical problem, and it is readily shown how closely we humans adhere to statistical laws in speech and language!

I have so far referred mainly to speech and hearing. Now a word or two about sight. This is of prime interest to television and facsimile and, once again, our attention is forced upon human perception when we come to consider the question of bandwidth compression.

As I look around me I think I see a room and see it whole. Yet the fovea of my eye, or angle of sharp vision, is only 1°. Moreover, my eye travels not smoothly but in a series of rapid jerks, called saccades, resting on each point of fixation for about a quarter of a second. From all this spasmodic, disjointed sense data, I construct my image of this room. Again it is a question of stored experience; walls are straight, ceilings flat. I receive some small stimuli and conjure up the rest.

The ready perception of truly familiar patterns is illustrated by flashing up some well-known sign on a screen for a very short duration—far too short for the eye to make any saccadic exploration of its form. If words are projected, misspelt, you will

see them to be correct, just as you can overlook a printer's error.

The eye moves along the lines of print whilst reading a book in this same jerky manner, pausing only at 2, 4 or say 6 points per line, depending upon the textual difficulty. For "difficulty" read "probability" here and we may be nearer the mark. We need to know far more about the control exerted by the text, in terms of probabilities, upon the eye movements. Again, and this in relation to television, we need to know far more about the way in which the eye scans scenes. In detail, we need to know what are the "bricks" which habitually build up scenes in our minds; we certainly perceive sharp edges and corners, but what other geometric forms exert control and what elements of patterns are unperceived because of prior knowledge, being inferred or conjured up?

All scenes, just like all utterances, are highly redundant in information, and this redundancy helps us to overlook errors in real life. In compressed television or telephony, we aim to reduce this redundancy and it is axiomatic that in so doing we raise the probability of error. But the "matching" problem is this, that we need to reduce those redundant elements of signals which are insignificant to perception; the errors then made are without serious consequence. And to do this we need to know vastly more about human aural and visual perception.

Answer to the Fig. 2 puzzle: the buried sign is the letter "E."

Inexpensive High-Quality Amplifier

(Continued from page 113 of the previous issue)

Measured Performance and Some Comparative Listening Tests

By P. J. BAXANDALL, B.Sc.(Eng.)

IN view of the simplicity of the design, and the large margins left with respect to d.c. operating conditions and feedback stability, it is unlikely that any troubles will be experienced if the construction has been done carefully—the required performance should be obtained straightaway. A few d.c. voltages should preferably be checked, however, and should fall within the following limits:—

- (a) Centre-tap of output transformer primary to earth: 280 to 320 V
 - (b) V1a cathode to earth: 1.2 to 1.8 V
 - (c) Decoupled h.t. supply to V1: 265 to 305 V
 - (d) V1b cathode to earth: 50 to 90 V
 - (e) Output valve cathodes to earth (The two cathode voltages should preferably not differ by more than 0.75 V.) 6.0 to 8.5 V
 - (f) Output valve screens to earth: 180 to 230 V
- The total h.t. current should be within the limits 60 to 80 mA.

If an audio-frequency oscillator, valve voltmeter

and c.r.o. are available, it is worth checking that an output of 5 watts can be delivered into a 15-ohm load resistor (8.66 V r.m.s.) over the frequency range 35 c/s to 10 kc/s, without visible signs of distortion.

It is necessary, of course, to ensure that the output transformer is connected so that the feedback is negative. If the transformer has been wound as intended, negative feedback will result when V3 anode is connected to the primary section on the outside of the winding. Should a mistake have been made, violent oscillation will make this very evident, and the amplifier should be switched off immediately!

Performance Measurements on Prototype.—Numerous measurements have been made with the circuit, using the Gilson prototype output transformer, and some of the results are presented in Figs. 6, 7, 8 and the oscillograms. With reference to Fig. 8, it may be added that higher-order harmonics are of very much smaller amplitude than

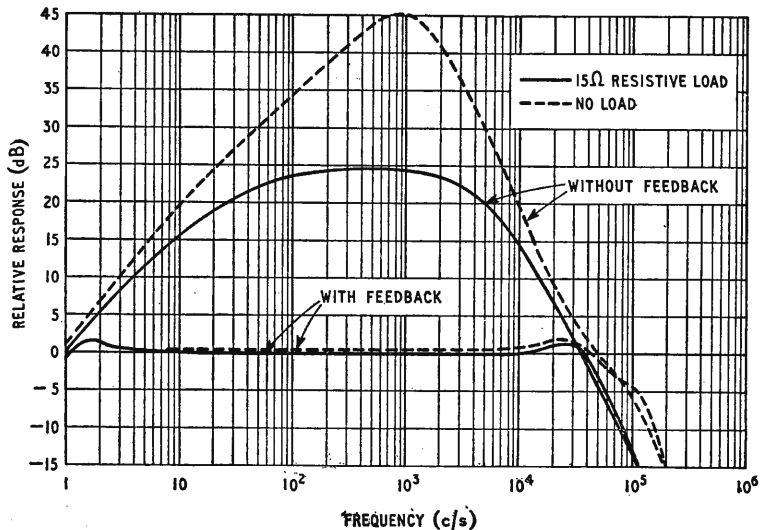

Fig. 6. Measured frequency-response curves for Fig. 1 circuit. (The output voltage was kept constant at approximately 0.1 v r.m.s. during these measurements.)

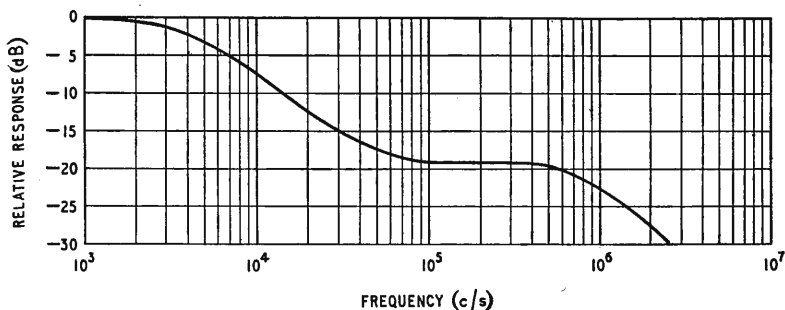

Fig. 7. Measured frequency response between V1a grid and V1b cathode, with overall feedback disconnected.

the 2nd and 3rd harmonics, and that they fall off very rapidly in amplitude with increasing order, as would be expected in a class A amplifier. The second-harmonic distortion is generated mainly in the input stage.

Some figures deduced from the measurements are as follows:—

(a) At 500 c/s there is just over 24 dB of feedback.

(b) The effective internal resistance of the amplifier, measured at the 15-ohm output terminals at 500 c/s, is approximately 0.7 ohm; this corresponds to a damping factor of just over 20 or to a damping ratio of approximately 0.96.

(c) The hum output is approximately 80 dB down on 5 watts, and corresponds therefore to 0.05 microwatt.

(d) The total mains power consumption is approximately 50 watts.

Listening Tests.—Some of the physical performance figures for this amplifier are inferior to those which apply to the highest grade amplifiers available today; this is inevitable, of course, in such a highly economical design. The really important

question, however, is whether the results obtainable are in any way *audibly* inferior to those which can be obtained with amplifiers of the highest grade, and to find the answer to this question some careful listening tests have been made.

These tests were carried out both in the author's own home, where the living room has dimensions 21ft 6in × 13ft 6in, and also in the considerably smaller living room of a friend, Mr. S. W. Noble; in the latter case, however, there was the advantage of a loudspeaker (Acoustical Manufacturing Company's corner ribbon) whose performance, particularly at very high frequencies, is rather better than that of the author's loudspeaker. The equipment associated with the corner ribbon speaker consists of main and pre-amplifiers by the Acoustical Manufacturing Co., fed from either their f.m. tuner or an Ortofon pickup with diamond stylus. The equipment used with the author's loudspeaker is of generally similar quality.

In all tests the 5-watt amplifier was arranged as in Fig. 9, so that it could be instantly switched in or out of circuit, the 1-kΩ potentiometer having been carefully set, with the aid of an oscillator, so that the same voltage was delivered to the

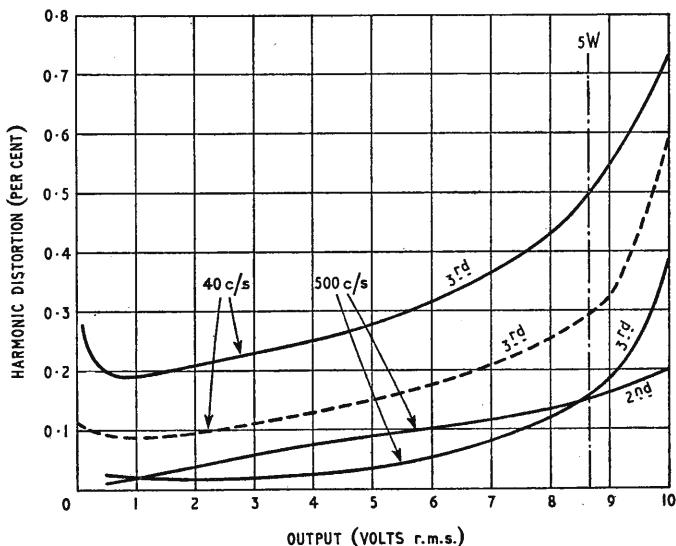

Fig. 8. Variation of second- and third-harmonic distortion with output voltage, on 15-ohm resistive load. Other harmonics are of much smaller magnitude. The dotted curve was obtained with a Partridge type P4077 transformer with grain-oriented silicon steel laminations.

loudspeaker for either position of the changeover switch.

To obtain information on the signal levels actually being fed to the loudspeaker during the tests, a simple peak programme meter was used. This is really a peak-reading valve voltmeter, in which the diode rectifier circuit has a charging time-constant of well under 0.1 millisecond and a discharging time-constant of 5 seconds. The circuit thus responds to transients of the shortest duration and the needle falls back slowly enough for the peak value to be satisfactorily indicated and read. The dial is calibrated in watts, using a sine-wave source and assuming the meter to be connected across a 15-ohm resistive load. For example, with 8.66 V r.m.s. applied to the meter, the reading obtained is marked "5 watts," since $(8.66)^2/15=5$; and so on for various other input levels. With this method of calibration, an amplifier rated at 5 watts in the usual manner (i.e., capable of giving a mean output power of 5 watts into a 15-ohm resistive load on sine-wave input) should be just capable of giving a meter reading of 5 watts on programme input without overloading.

Most of the tests were made using long-playing records, which were all good examples of modern recording technique and which covered a wide range of different kinds of music. The listeners were all sound-reproduction enthusiasts with a keen interest in music as such. The author, in most of the tests,

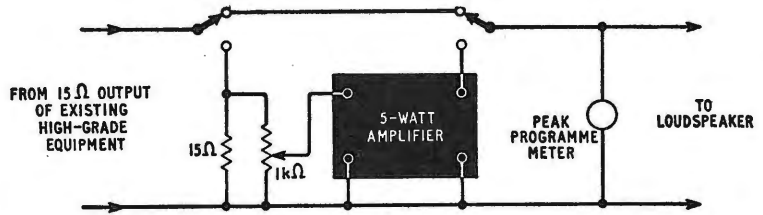

Fig. 9. Switching arrangements for comparative listening tests.

left the choice of volume control setting to other people, on the grounds that he had, so to speak, a vested interest in proving that high peak power levels were unnecessary. The procedure, then, was to ask a listener to set the volume control, with the author's amplifier switched out, to his chosen setting, observe the peak readings reached on that recording, and then replay the recording, or selected sections of it, with the author's amplifier switched in. Quick changeovers were also made, on numerous occasions, during particular passages of music. The results of the tests may be summarized as follows:—

(a) Provided peak readings beyond the 7-watt mark were not reached, no deterioration at all in quality could be detected by any listener when the author's amplifier was switched in. The same conclusion was reached when the amount of feedback in the amplifier was reduced by 6 dB, this being done by switching in a suitable potential divider into the feedback path, another section of the switch inserting a suitable attenuator in the grid circuit so that the gain of the amplifier was unaffected by operating the switch. The amplifier would thus appear to have an adequate margin to spare as far as audible distortion is concerned.

(b) Readings in excess of 5 watts were almost never reached, the only occasions when they were being momentarily during two or three extreme *fortissimo* passages of large orchestral works as reproduced in the living room of the above-mentioned friend, with the volume control set by this friend. On one occasion, during Beethoven's "Eroica" symphony (Columbia 33CX 1346), a reading of 8 watts was reached. On switching in the author's amplifier for this climax, there was a noticeable roughness for a fraction of a second, but apart from this there was no detectable loss in quality. Another record used in the tests, which produced peak readings up to 7 watts, was Holtz's suite "The Planets" (Nixa NLP 903).

(c) Much lower peak levels were reached, as might be expected, during music of a less dynamic variety. There was general agreement that most light orchestral music could be reproduced at what appeared to be a fairly realistic level without exceeding peak readings of about 2 watts, and that many people preferred to listen at an even lower level. During reproduction, in the author's living room, of a very good piano record (Sonata No. 3 in B Minor, by Chopin, on H.M.V. ALP 1243), peaks of just over 3 watts were reached, the reproduction giving the impression of being about full scale.

(d) On organ music an exceedingly great volume of sound could be produced, in the author's living room, with the volume control set so that extreme peaks went up to 5 watts; as, for example, during the conclusion of Bach's Fantasia in G Minor on

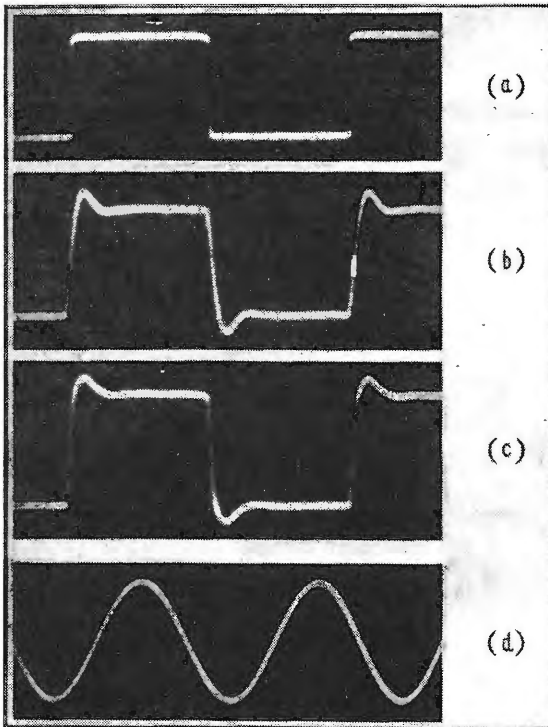

(a) 5-kc/s square-wave input signal, and (b) and (c) corresponding output waveforms with 15-ohm resistive and no load respectively. (d) Waveform across 15-ohm resistive load at a mean output power of 5 watts, for 35-c/s sine-wave input.

Decca LXT 5029 ("Bach Organ Recital")—a very good organ recording. The most striking thing, on watching the programme meter during this recording, with the volume control set as above, is that, for the great majority of the time, even during quite loud passages, the needle does not go above the 1 watt mark.

The amplifier has been found to be capable of handling heavy organ pedal passages, at its full output level, without an audible increase in distortion compared with a higher-grade amplifier.

(e) On talks, news bulletins, etc., at a fairly average sort of listening level, the peaks were much less than 0.1 watt.

Thus it may be concluded that this amplifier has sufficient available power for most normal domestic applications, and that its distortion is negligible as judged aurally. By using a larger amplifier, very little, if any, advantages would in actual fact be gained, but some readers, addicted to listening at very high volume levels, will no doubt prefer a larger amplifier, if only to give them the feeling of being more comfortably free from the risk of overloading it.

It may be mentioned that the author's loudspeaker, whilst probably a little more sensitive than the Acoustical corner ribbon speaker already referred to, is not of exceptionally high efficiency as high-quality loudspeakers go. With loudspeakers such as the G.E.C. metal cone speaker, whose sensitivity is low, some people would, no doubt, complain of a shortage of available power using this amplifier. A loudspeaker unit which has, on the other hand, quite a high efficiency, and which, in the author's opinion, has much to recommend it when economy must be considered, is the Goodmans Axiom 102. When properly loaded acoustically, this unit seems to be capable of remarkably good reproduction, as demonstrated, for example, in the Junior Corner Horn made by Rogers Developments, Ltd.

Electrostatic Loudspeakers.—The opportunity of trying this amplifier with a full-range electrostatic loudspeaker has not yet presented itself, but it is thought that a few comments regarding the feasibility of using it with such a loudspeaker might be welcomed. These loudspeakers, in the form made during the earlier stages of commercial exploitation, will contain matching transformers to suit them to use with amplifiers primarily designed for feeding 15-ohm moving-coil loudspeakers. The variation of impedance with frequency is, however, very different with an electrostatic loudspeaker, compared with a moving-coil one, and difficulties are likely to be experienced with some amplifiers in the form of high-frequency oscillation caused by the capacitive nature of the load presented by the electrostatic loudspeaker. Assuming the loudspeaker to be matched so that its impedance is 15 ohms at 5 kc/s, this means that it will look approximately like a capacitor of about $2\ \mu\text{F}$ at high frequencies—except in so far as this may be modified by the presence of leakage inductance and resistance in the loudspeaker transformer or by the introduction of other separate stabilizing elements by the loudspeaker manufacturer.

Taking the worst likely case, i.e., that the loudspeaker looks like a pure $2\text{-}\mu\text{F}$ capacitor at high frequencies, it is necessary, with the present amplifier, to include some resistance in series with the $2\text{-}\mu\text{F}$ load in order to secure a satisfactory margin of high-

frequency stability. A value of 3 ohms is suitable, and gives a large stability margin whilst having a negligible effect on the frequency response up to 15 kc/s. To prevent the introduction of such a resistor from producing an appreciable increase in non-linearity distortion in the loudspeaker transformer core at low frequencies, the best practice would be to shunt it with an air-cored inductor whose value is very uncritical but which should be in the region of 0.5 mH.

It should be emphasized that the above precaution may be unnecessary—it may turn out to have been taken by the loudspeaker manufacturer.

APPENDIX

Peak Programme Meter

The circuit is shown in Fig. A. The simplest calibration procedure is as follows:—

(a) Set switch to "Off" and adjust "Set Zero" control to give exactly 1 mA through meter.

(b) Set switch to "Cal," thus applying an input of approximately 6.3 V r.m.s. from the heater supply, and adjust "Sensitivity" control to give exactly 0.5 mA through meter.

(c) Set switch to "Use" and apply sine-wave input voltages of various known values corresponding to mean

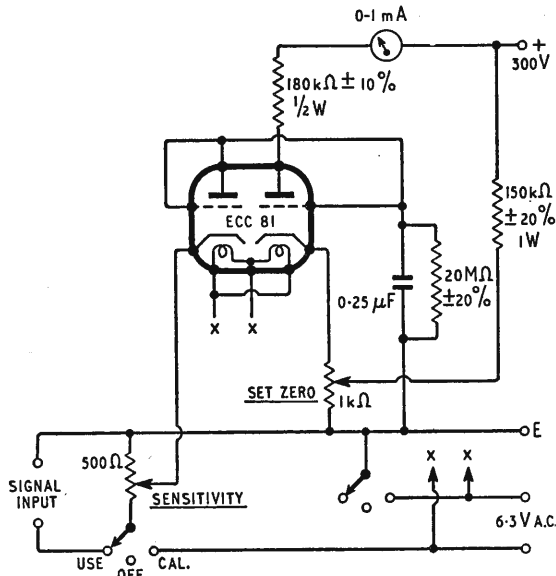

Fig. A. Circuit of simple peak programme meter used in listening tests. Alternative valve types are 12AT7, Osram B309 or Services type CV455.

TABLE

Mean Power (Watts)	Voltage across 15- (r.m.s.)	Meter Current (mA)
0.1	1.22	0.91
0.2	1.73	0.86
0.5	2.74	0.78
1.0	3.88	0.69
2.0	5.48	0.56
2.65	6.30	0.50
3.0	6.72	0.46
4.0	7.75	0.39
5.0	8.66	0.33
6.0	9.48	0.28
7.0	10.2	0.24
8.0	11.0	0.20
9.0	11.6	0.17
10.0	12.2	0.14

power levels of 1, 2, 3, etc., watts in a 15-ohm load, and mark the scale off in watts correspondingly. The voltages required are given in the table, which also gives the currents obtained through the meter in the author's version of the circuit. Readers unable to supply known a.c. voltages for calibration purposes can adopt the author's calibration as given in the table; sufficient accuracy for ordinary purposes should be obtained in this way, but individual calibration is really preferable since the scale shape is dependent to some extent on individual valve characteristics.

Ideally the meter movement should be so damped that it just does not overshoot when a sudden change of current occurs. Ordinary meters vary a good deal in this respect; the one used by the author is made by Pullin, Ltd., and has the right degree of damping for

the purpose. It is used upside down, so that an increase in signal level gives a pointer movement to the right. This particular meter has a case 2½ in diameter.

A shortcoming of this simple programme meter is that it employs a half-wave rather than a full-wave rectifier. This is unimportant provided the signal waveforms are symmetrical, and it seems that most music waveforms are fairly symmetrical with the exception of those involving the male voice. It may easily be demonstrated, using a ribbon microphone, that different readings are obtained on male speech, to the extent of 3 dB or more, according to which side of the microphone faces the person speaking⁴.

⁴ "Amplitude Modulation Up to Date," by O. J. Russell, *Wireless World*, March 1943.

BOOKS RECEIVED

An Automatic System for Synchronizing Sound on Quarter-Inch Magnetic Tape with Action on 35-mm Cinematograph Film, by L. H. Griffiths, M.A., B.Sc., A.M.I.E.E., and N. W. Woodward, B.Sc.(Eng.), Grad.I.E.E. B.B.C. Engineering Monograph No. 10 describes equipment in which a 50 c/s reference signal on the tape is compared with the mains supply frequency and the phase error is corrected by supplying the capstan motor through a "selsyn differential" operating as a continuously variable phase-shifting transformer. Pp. 14; Figs. 8. Price 5s. B.B.C. Publications, 35, Marylebone High Street, London, W.1.

A Simple and Versatile R.F. Measuring Circuit, by J. Miedzinski, B.Sc., and S. F. Pearce, B.Sc., A.Inst.P. Electrical Research Association Technical Report M/T120 describes "constant input," "constant output" and "constant attenuation" methods of measuring the impedance-frequency characteristics of filter components. Pp. 11; Figs. 6. Price 10s 6d.

The Properties and Design of Iron-cored Suppression Chokes, by J. Miedzinski, B.Sc. Electrical Research Association Technical Report M/T121. A comprehensive treatise including a series of design charts. Pp. 29; Figs. 11. Price 24s. The Electrical Research Association, Thorncroft Manor, Dorking Road, Leatherhead, Surrey.

Graphical Symbols for Telecommunications. Supplement No. 4 to B.S.530:1948. Miscellaneous recommendations and symbols including transistors. Pp. 22. Price 3s 6d.

Supplement No. 5. Functional symbols for switching diagrams with particular application to electronic circuits. Pp. 14. Price 2s 6d.

Safety Requirements for Radio or other Electronic Apparatus for Acoustical or Visual Reproduction. B.S.415:1957. Includes specifications for standard "test finger" and testing of cathode ray tube implosion guards. Pp. 31; Figs. 3. Price 6s. British Standards Institution, 2, Park Street, London, W.1.

A.C. Synchro Systems for Civil Aircraft. Survey of torque, control and resolver synchros and their uses, and of British and American wiring conventions. Pp. 27; Figs. 27. Price 10s. Radio Communication and Electronic Engineering Association, 11, Green Street, London, W.1.

Mathematical Tables Vol. 1. The Use and Construction of Mathematical Tables, by L. Fox, M.A., D.Phil. General introduction to a series of tables for use in computational problems to be prepared by the Mathematics Division of the National Physical Laboratory, D.S.I.R., with a bibliography of the subject. Pp. 59+IV. Price 17s 6d. Her Majesty's Stationery Office, York House, Kingsway, London, W.C.2.

Theorie und Technik der Pulsmodulation, by E. Hölzler, Dr.Ing., and H. Holzwarth, Dr.Ing. Treatise on pulse generation and modulation by amplitude, width, spacing and other methods. The problems of noise and an outline of practical pulse communication systems are also included. Pp. 505+XIV; Figs. 417. Price DM57. Springer-Verlag, Reichpietschufer 20, Berlin, W 35.

Tubes for Computers (Philips Technical Library). Introduction to switching circuits with specific circuit designs for use with selected Philips valves. Pp. 52. Figs. 59. Price 9s 6d.

U.H.F. Tubes for Communication and Measuring Equipment (Philips Technical Library). Selected valves, including disc seal types, and circuits for use at 300 Mc/s and above. Pp. 70; Figs. 76. Price 9s 6d.

Tube Selection Guide, 1956-57, by Th. J. Kroes (Philips Technical Library). Classification of Philips valves and their equivalents including transmitting valves with their maximum operating frequencies, arranged according to function and availability (current, replacement or obsolete). Pp. 124; Figs. 32. Price 9s 6d.

The Cathode Ray Oscilloscope, by J. Czech (Philips Technical Library). Comprehensive practical treatise on the design, construction and use of the c.r.o. as a measuring instrument with practical examples of investigations on television receivers and on the behaviour of the luminous flux from incandescent and fluorescent lamps. Pp. 338; Figs. 407. Price 57s 6d.

All the above Philips Technical Library books are obtainable through the Cleaver-Hume Press, Ltd., 31, Wrights Lane, London, W.8.

T.V. Conversion for I.T.A., by C. E. Lotcho. Detailed practical guide to the conversion of the leading makes of Band I British television receivers for use on Band III. Lists are included of intermediate frequencies and of models which are aligned to the upper sideband. Pp. 240; Figs. 170. Price 25s. George Newnes, Ltd., Tower House, Southampton Street, London, W.C.2.

Transistor Techniques (Gernsback Library). Collection of articles from *Radio-Electronics* designed to give familiarity with the properties and uses of transistors in simple practical applications. Price 12s through The Modern Book Company, 19-23, Praed Street, London, W.2.

The Electronic Musical Instrument Manual, by Alan Douglas. Revised and enlarged third edition. Pp. 247; Figs. 216. Price 35s. Sir Isaac Pitman and Sons, Ltd., Parker Street, London, W.C.2.

Television Techniques, by Hoyland Bettinger and Sol Cornberg. Guide to the writing and production of television programmes. Pp. 266; Figs. 32+XVI. Price 21s. Frederick Muller, Ltd., 110, Fleet Street, London, E.C.4.

Reading by Electronics

AUTOMATIC CHARACTER RECOGNITION USING LOGICAL GATE CIRCUITS

VERY few of the automatic reading machines invented during the past 25 years or so have got past the experimental stage. The main difficulty seems to be in making them flexible enough to cope with different character styles, imperfections in printing, spots of dirt on the paper and so on, at the same time as achieving an absolute reliability of recognition. Some of the earlier schemes were intended as aids to the blind, but in recent years the emphasis has shifted to the requirements of the modern business office.

Here automatic readers are needed for rapid translation of printed figures from typewriters, cash registers, time clocks, ticket printing machines and so on into the medium of punched cards (or perhaps punched tape or magnetic tape) for feeding into existing business machines. Normally this job is done by human labour, and it takes a long time as well as costing a lot of money. It produces a "bottleneck" in the mechanized processing of information which is a particular disadvantage when, say, a rapid analysis is required of yesterday's sales figures. Moreover, this bottleneck becomes even more obvious now that high speed electronic computers are being introduced into the business field.

Most electronic reading systems work on the same general principle. The printed characters are fed in turn past a scanning system, either electronic or electro-mechanical, which converts each one into an electrical pattern corresponding to the disposition

of light and dark on the paper. This electrical pattern is then compared with reference patterns, representing the complete range of possible characters, stored inside the machine. When a correspondence is detected a signal indicating the appropriate character (perhaps in binary or some other code) appears at the output. In one American machine, for example, the comparison of patterns is done by cross-correlation techniques. Circuits working on probabilities have also been suggested.

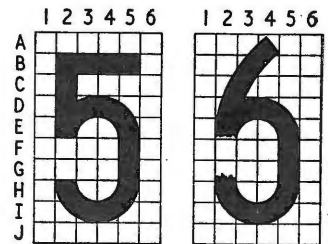
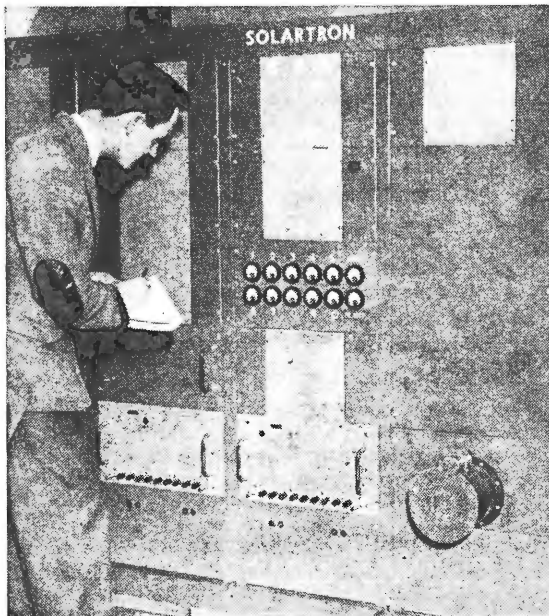

Fig. 1. Basic method of analysing a character into small black/white "picture elements" suitable for binary electronic circuits.

One recent trend is towards the use of logical circuits of the kind found in digital computers—notably the so-called "AND" and "OR" gates. Fig. 1 illustrates the general idea behind this approach. Supposing the characters are analysed into "picture elements" as shown, it is possible to identify a character by the fact that certain elements are either predominantly black or predominantly white. There are only two conditions, corresponding to "on" and "off" in electrical form, and this is what makes it possible to use the logical two-state gating circuits. In dealing with the left-hand figure, the circuits might detect the break in the circle (squares F2 and G2) and therefore decide that it could belong to either a "3" or a "5." In this respect it could also belong to a broken "6," as shown on the right. But the circuits would also find that there is black in B2 and B5 as well as in B3 and B4, so therefore the character in question is "5" and not "6."

The electronic circuits in these "logical" machines, then, have to work on statements of identification something like this: "If black is either in B5 and F2 or D3 and J5, and is in F6 and H5, but is not in E4 or G3, then the character is '4.'" The *ands* and *ors*, of course, are instrumented by gate circuits performing these functions, and it is the interconnections of the gates which provide the reference patterns against which the incoming characters are tested. This kind of principle is actually used in a machine recently developed by Solartron which can recognize numerals at the high rate of 120 per second. It has to be "programmed" for different type-founts, but allows for all the variations of pattern caused by bad or misregistered type, smudging, dirt on the paper and so on which one expects to find on ordinary business documents.

A block diagram of the Solartron machine is shown



The Solartron machine is about the same size as a small digital computer and costs in the region of £20,000-£50,000. Here, monitoring meters are being read.

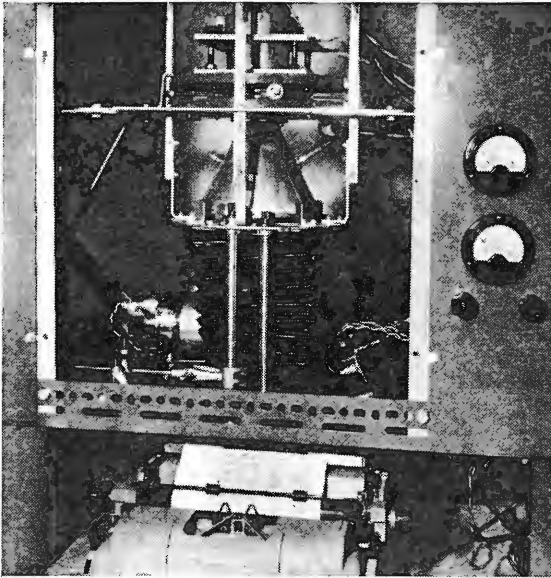

Flying-spot scanner of the Solartron machine.

in Fig. 2. A paper feed mechanism moves the characters in turn past a flying-spot scanner, and the variations in reflected light resulting from the scanning process are picked up by a photo-multiplier tube. The signals from this are amplified and then

passed through limiting circuits which clip the top and bottom of the waveform. This establishes definite black and white levels which are independent of the heaviness of the printing, the condition of the paper and so on.

The actual scanning is done in ten vertical lines, and each line can be considered as being divided into 10 picture elements. Thus there are 100 picture elements altogether, each of which will be either predominantly black or predominantly white. The scanning speed is synchronized by the clock pulse generator (of 500-kc/s p.r.f.). The output of this is frequency divided down to give a line scan period corresponding to 10 picture-element periods (the "units generator") which is used to synchronize the vertical deflection. Another frequency divider (the "tens generator") then gives a signal for synchronizing the horizontal deflection.

There are actually two scanning cycles for each printed character. The first is used for automatic registration of the scanning raster on to the centre of the character, while the second is the actual reading period. This accounts for the "register/read gate" which, under the control of the timing generators, causes the photo-multiplier output to be switched either to the registration system or to the 100-element matrix store. The distribution of the black and white picture elements to corresponding positions in this matrix store is done by a 100-way gating system under the control of the "units" and "tens" generators. The actual storage is done by the "on" and "off" conditions of 100 two-state circuits arranged in matrix form with ten X inputs and ten

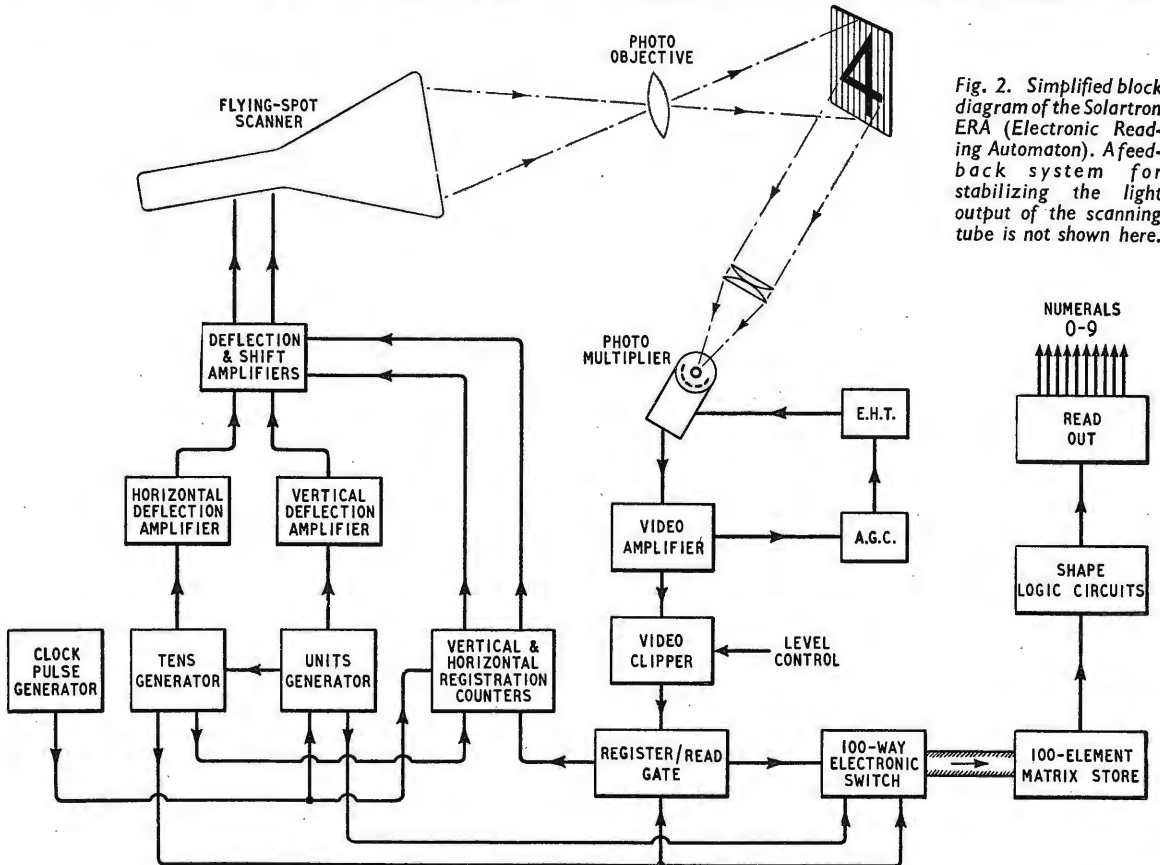

Fig. 2. Simplified block diagram of the Solartron ERA (Electronic Reading Automaton). A feedback system for stabilizing the light output of the scanning tube is not shown here.

Y inputs, but capacitors are likely to be used for this purpose in the future.

From the store the "on-off" pattern representing the read character is applied to the logical recognizing circuits, which work on the kind of principles mentioned above. The actual arrangements of gates are extremely complicated, but in general terms the initial identification processes are performed by groups of "OR" gates which, by their nature, allow for certain possibilities and variations in the patterns. The really conclusive and final decisions are then made by groups of "AND" gates, which are fed from the outputs of the "OR" gates. An "AND" gate is essentially a coincidence detector and only gives an output when the required set of electrical conditions is applied to its inputs simultaneously. Germanium diodes are used for these "OR" and "AND" circuits, and the interconnections between the gates (i.e., the reference patterns determining which paths the input information shall take) are set up, or "programmed," by printed-circuit boards.

At the end of the recognition process for each character a signal appears on one of the ten output

wires (representing the numerals 0, 1, 2 . . . to 9) and this can be used for operating, say, a card punch or the keyboard of an automatic typewriter. The output signals can also be fed directly into a digital computer after conversion into binary-coded decimal digits taking the form of serial pulse trains.

The registration or centring process mentioned earlier is achieved by detecting the position of the top, bottom, left and right extremes of the character in the initial "register" scan, then applying appropriate X and Y shift voltages to the scanning tube during the "read" scan. For horizontal registration, a counter is used to count the number of vertical scan lines from the left to the first and last picture elements which have any black content. Half of the difference between these two counts (i.e., the centre of the misregistered character) then gives a measure of the shift from centre to be applied to the existing scan. For vertical registration a similar process is used, working with numbers of elements instead of lines. Any progressive tendency in character misalignment is corrected by a servo system on the paper feed mechanism.

MARITIME V.H.F. RADIO

A Step Nearer World-Wide Agreement

By **CAPTAIN F. J. WYLIE*** R.N. (Retd.)

TO those who have no direct or personal interest in them, one international radio conference is, no doubt, very much like another. So it seems desirable to emphasize the unusual nature and potential of the Agreement which was concluded at the Maritime V.H.F. Radiotelephone Conference at The Hague in January. It is not every day that a door is opened on to a new field of international telecommunication, but this is in fact what was done at The Hague for maritime v.h.f. The written Agreement was signed only by its originators, the Baltic and North Sea countries, but it is hoped that other maritime countries will accept it as a basis for universal co-operation, so that the seal of the International Telecommunication Union may be set upon it at its next Administrative Radio Conference in 1959. The U.S., Canadian and Italian representatives who were present at The Hague were in general accord.

The main purpose of the recent conference was to turn the informal Gothenburg agreement of 1955† and the technical recommendations made by the C.C.I.R. (International Radio Consultative Committee) at Warsaw in 1956 into a working arrangement, which would avoid a delay of nearly three years in establishing international maritime v.h.f. services. Many of the maritime countries of the world had already voiced their agreement with the principles of the Gothenburg plan.

In effect, the task of the conference was so to con-

struct the frequency plan and the regulations for its use, that ships equipped with v.h.f. sets of economical design could depend on obtaining good service in any part of the world. This problem may sound precisely similar to that long since accomplished for wireless telegraphy in the 500 kc/s band and for telephony on 2 Mc/s. Apart from intership working, these m.f. services are, however, provided entirely on the basis of public correspondence through coast stations which in most countries are operated by the Administration. On the other hand, the v.h.f. services have to include facilities for direct communication with quite a variety of port and dock services. The operational nature of these lines of communication necessitates planning with one eye on system versatility and the other on the size and cost of the ships' equipment.

The port operational service required some definition so that it should not carry traffic which should properly be sent on public correspondence channels. It was agreed that its use should be restricted to messages related to the movement and the safety of ships and, in emergency, to the safety of persons. It was appreciated that in the vicinity of a port a ship's movement may be affected by administrative matters, such as customs or on medical grounds.

The frequency allocation table given overleaf is, of course, the foundation of the whole structure and it needs some explanation. It is based on 50 kc/s channel separation and each of the 26 usable channels is designated by a number and nominated for either single- or two-frequency working; interleaving of the

* Radio Advisory Service of the Chamber of Shipping and the Liverpool Steam Ship Owners' Association.

† See *Wireless World*, April, 1956.

two methods was avoided as far as possible. For port operations it was considered necessary to allow for both methods of working. Because of the varying demands and planning considerations in different localities the principle of allocating a few exclusive channels to each service and to specify the sequence in which they should be taken into use was adopted.

FREQUENCY ALLOCATION TABLE

Channel	Ship Frequencies (Mc/s)		Inter-ship		Port Operations		Public Correspondence	
	Transmit	Receive	Single-Freq.	Single-Freq.	Two-Freq.	Single-Freq.	Single-Freq.	
1	156.05*	160.65			10		8	
2	156.10	160.70			8		10	
3	156.15*	160.75			9		9	
4	156.20	160.80			11		7	
5	156.25	160.85			6		12	
6	156.30	156.30	1					
7	156.35	160.95			7		11	
8	156.40	156.40	2					
9	156.45	156.45	5	5				
10	156.50	156.50	3					
11	156.55	156.55			3			
12	156.60	156.60			1			
13	156.65	156.65	4		4			
14	156.70	156.70			2			
15	156.75	Guard-band (156.725—156.775Mc/s).						
16	156.80	156.80	Calling and safety					
17	156.85	Guard-band (156.825—156.875Mc/s)						
18	156.90	161.50			3			
19	156.95	161.55			4			
20	157.00	161.60			1			
21	157.05	156.05*			5			
		or 161.65						
22	157.10	161.70			2			
23	157.15	156.15*					5	
		or 161.75						
24	157.20**	161.80					4	
25	157.25	161.85					3	
26	157.30	161.90					1	
27	157.35	161.95					2	
28	157.40	162.00					6	

* In the special semi-duplex public correspondence used in France and Belgium and possibly elsewhere, these frequencies are for "ship receive."
 ** When required this channel will be used as a two-frequency calling channel and also for selective calling.

If no sequences were laid down, it would be impossible to decide what channels should be included in ships' equipments to give them the services they need. The sequences are applicable to each station, ship or coast, not merely to each country. Further, as an additional safeguard in the ships' interest, Administrations are enjoined to provide a reasonable service to ships with equipment covering only the channels indicated in heavier type in the table. The public correspondence service has one more "essential" channel, as three seems to be the minimum number on which an effective one-channel, continuous coverage coastal service can be arranged.

All the normal two-frequency channels use a spacing of 4.6 Mc/s between transmit and receive frequencies, but it will be noticed that channels 1, 3, 21 and 23 may also be used for special public correspondence services in certain countries, in such a way that the spacing is only 1 Mc/s; this enables simpler and cheaper equipment to be used, but the ship must employ press-to-talk (simplex) operation. The 4.6 Mc/s separation is a departure from precedent and is based on reports from U.S.A. of interference caused to ships using duplex operation (with 4.5 Mc/s separation) when in the vicinity of television transmitters using the same separation

between sound and vision channels. The interference is due to intermodulation products.

Apart from this the technical requirements in the Agreement follow the Warsaw recommendations, the principal of which are:—

- Frequency modulation with pre-emphasis of 6 dB per octave;
- Channel separation 50 kc/s;
- Maximum deviation ± 15 kc/s;
- Frequency tolerance $\pm 0.002\%$.
- Maximum output power 20 watts except in special circumstances.

The supplementary radio regulations which were recommended, require a ship equipment for working in the international bands to be able to use channels 6 and 16. The *minimum* equipment permissible will, therefore, be a 2-channel set but the majority of ships which will fit v.h.f. are likely to need at least the single-frequency port operations service in addition. It is difficult at this stage to forecast the shape of things to come and, partly because of this, the minimum *useful* single-frequency equipment seems likely to need perhaps 6 channels. The ship owners who intend to make economical but *comprehensive* use of the services which may be available fairly widely in a few years time, are likely to add up the "essential" channels, add two or more for fair measure and, therefore, look for a 12- or 14-channel set.

It has to be remembered that when v.h.f. has become a commonplace in ship communications the use of portable equipment brought on board by pilots, for use during port entry and departure, will have ceased to have any attractions. This implies, however, that ship equipment must provide sufficient channels for all the essential services. The total needed may well be more than those suggested, but multi-channel sets with accommodation for additional channels should be obtainable with very little increase in cost. An alternative would be to use "unit" equipment which could be added to, economically.

No doubt many attractive alternatives will be offered by manufacturers in the near future. Ships, however, will not fit equipment until services are available, so the next move seems to be with the port authorities to provide operations and information services, and the Administrations or radio operating companies to provide public correspondence facilities. The services envisaged in The Hague Agreement are largely to carry "ships' business" traffic. No doubt a certain amount of passenger traffic will be taken but the Agreement recognizes the need for the v.h.f. set to be controlled from the bridge. Major passenger public correspondence was not included in the Agreement; this important matter is for discussion elsewhere. The great thing is that the door to progress is now open; the Agreement comes into force on 1st October this year.

"LIMITERS AND DISCRIMINATORS FOR F.M. RECEIVERS"

The continuation of Part 3 of this series, by G. G. Johnstone, is unavoidably held over until the May issue. It will deal with practical design considerations for radio detectors and will also assess the relative merits of the Foster-Seeley and other detector circuits

LETTERS TO THE EDITOR

The Editor does not necessarily endorse the opinions expressed by his correspondents

"Limiters and Discriminators for F.M. Receivers"

MR. G. G. Johnstone has raised an interesting issue in his article in the January, 1957, issue. He agrees that the use of wide-band limiter and discriminator circuits is advantageous in suppressing small amounts of f.m. interference, but says of a narrow-band detector: "in the region where a is greater than unity, a reduction in discriminator bandwidth causes the amplitude of the spikes to be reduced and the signal-to-noise ratio is better than for a wide-band discriminator."

He may like to know that we made no very subtle choice between the relative nuisance values of co-channel and ignition interference, but rather failed to consider the point he has raised.

It is a very difficult matter to predict the response of a narrow-band detector to wide rapid changes in frequency. Some of us made static analyses of the type indicated in his Fig. 4, but found that although the method gives results that are qualitatively right the dynamics of the tuned circuits are such that experimental results differ considerably from the static analysis. However, I agree that for impulses that are slightly larger than the signal the narrow-band detector should be expected to give better results than the wide-band, particularly when the impulses simultaneously exceed the signal by small amounts and occur at a moment of high deviation. On the other hand, for impulses considerably larger than the signal, high spikes do not ordinarily result, and the two receiver types should give about the same results. Thus I feel that the narrow-band circuit would have advantages over the wide-band for only a small range in which ignition noise exceeds signal strength by a small margin and at high deviation; for all other cases the wide band should be equal or better.

Actually this feeling of mine is an over-simplification, since the maximum spike height depends upon signal/noise ratio, upon instantaneous phase, and upon the instantaneous frequency deviation present at the time the disturbance occurs. It would seem that the results calculated for some statistical distribution of all these factors would be by no means so simple as Mr. Johnstone and I have assumed. My own guess is that under these conditions the wide-band circuits may show up more favourably than would at first seem likely.

Mr. Johnstone's suggestion should also be of interest in the suppression of the effects of random noise. When a wideband detector operates on the combination of an f.m. signal and random noise the observed results are similar to those with ignition noise. For large values of S/N the output is clean, having at worst some "clicks." When the r.m.s. noise approaches within a few decibels of the signal, random "pops" of identical form are observed. The number of these pops per second increases rapidly as the value of S/N approaches 1. This experimental result is readily explained by considering the amplitude-modulated character of restricted-band noise, but I am not aware of any numerical statistical analysis of "pop" probability, an analysis that is difficult but should be worth carrying through.

In U.S. practice most receivers use narrow-band detectors. Many of them are inexpensively built and do not have flat i.f. responses, but may fall off by 5 or even 10 dB at the edges of the band. Further, many fail to limit properly on noise. When a fully modulated signal of small amplitude is impressed on such a receiver the response falls below limiter control and

noise on the peaks. As a result these receivers tend to distort badly on peaks not only because of spike clipping but for more earthy reasons as well. Receivers using wideband detectors are usually more carefully made in these routine ways, and it is not easy to say whether their observed superiority over narrow-band receivers in suppressing random noise is due to routine care or to their inherent properties. More experimental work is needed.

L. B. ARGUIMBAU

McIntosh Laboratory,
Binghamton, N.Y., U.S.A.

Audio Output Power

IT is to be hoped that P. J. Baxandall's amplifier design, published in your March issue, will herald a return to sanity in the field of domestic sound reproduction. His contention that an output of 5 watts is adequate in the home will be supported by many.

Large numbers of existing 10-15-watt amplifier designs are used with speakers which, even with acoustic loading, can handle little more than 5 watts. For these, the use of a lower-power amplifier would merely mean operation near the limit of the gain control setting, probably for the first time.

Percy Wilson recalls, in the same issue of *Wireless World*, that G. A. Briggs surprised many in the Festival Hall by the low readings given by his output power indicators. If my memory serves, the 5-watt mark was not often passed and during full orchestral reproduction peaks of 40-50 watts were indicated only occasionally. Further, I well remember that a demonstration was at that time given of reproduction from an 8-in acoustically loaded speaker which, without noticeable distortion but admittedly with some loss of realism compared with the multi-speaker system in use immediately beforehand, managed to produce a very fair sound intensity at a point well back in the hall. Had the music contained the largest peaks this speaker might well have overloaded at the existing gain control setting; I merely wish to suggest that power close to 5 watts was giving effects at the ear not vastly different from that produced by live music under identical conditions.

If modest power can give good results in the Festival Hall, surely a comparable figure should provide all the reserve required for peak reproduction in the average living room?

R.A.E., Farnborough.

W. E. DEAN.

Stereophonic Broadcasting

I AGREE with G. H. Russell (Jan. issue) that v.h.f. transmission offers an unprecedented opportunity for giving sound broadcasting a new lease of life, but I do not think that extension of h.f. response in a single channel is the best way of using the available bandwidth.

The human auditory mechanism is very intricate and is normally based on the transduction of separate stimuli at each cochlea into electrical waveforms, then into nerve pulses which are projected at both sides of the cortex. It is upon the relationship between these *two* different sources that our mind primarily depends for an appreciation of the spatial qualities of sound, and when this relationship is properly established our hearing is "contented"—much more so than by the "hi-fi" frequencies. As J. Moir has reminded us (Nov., 1956, issue, p. 543) "the frequency range that is produced seems

much less important than the sense of size and spatial distribution produced by the system."

It is often assumed that stereophonic broadcasting must be prohibitively expensive because two transmitters and separate sets at the receiving end would be required. This may have been true for medium-wave broadcasting conditions, but at v.h.f. a twin-channel a.m. stereophonic transmission could be accommodated in each 100-kc/s channel as indicated by the accompanying spectrum.

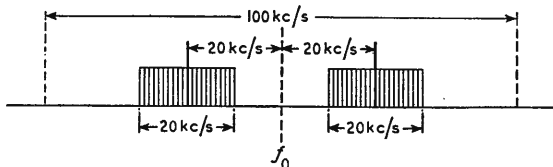

A single receiver of input bandwidth $W=60$ kc/s and a branched i.f. amplifier and audio channels would suffice for each transmission if limited in audio response to, say, 10 kc/s.

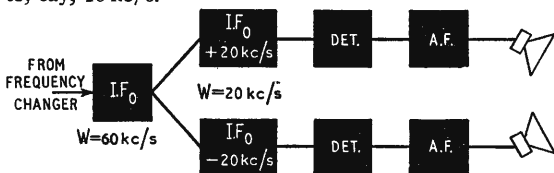

The service area would be limited by the distance at which variations of signal level due to anomalous propagation could be neglected, unless means could be devised for maintaining adequate relative levels at the receiver, but this should present no insuperable difficulty.

Ghent, Belgium,

H. A. V.

High-Quality Demonstrations

E. R. ASLIN (February issue) suggests that the pedal notes of an electronic organ can be used to test the bass response of a reproducer.

Although my original letter in the October issue dealt mainly with the problems encountered at high audio frequencies I pointed out in it that every electronic instrument uses, as the final sound source, a loudspeaker of uncertain age whose characteristics are usually unknown. Therefore, although bass tones of reasonable purity may be generated in an electronic organ we cannot know (without hearing it directly) how much fundamental tone is being emitted by the instrument's own loudspeaker. At high volume, some frequency doubling in the lowest octave is almost certain, and when the sound passes through a reproducing chain we can only conjecture how far each of the two loudspeakers contributes to this.

If the recorded signal were taken direct from the tone generating system we could be sure that all the tones generated were recorded without significant distortion. This might indeed be practicable for organ solos, but would be more difficult for concerted pieces, in which all the instrumentalists must hear their own music and that of their colleagues.

Sawbridgeworth,

H. GLOVER.

Beat Interference

YOUR article on the beat effect on reception from North Hessary Tor (March issue) is good enough for science fiction. But, before the inhabitants of Cawsand become afraid to go out in the dark, would it be possible to test for an unstable air-flow from the south-west? This is not so much within the province of meteorology as of aerodynamics and abnormal propagation. The

prevailing wind striking the coast could produce a waving airstream with eddies breaking away from it: this air, being of different humidity, could bend the waves and produce the effect of a huge swinging reflector. However inefficient, a very large reflecting or refracting surface might produce the observed effect where the direct signal was highly attenuated. This hypothesis might be tested by sending pulses across the suspected atmospheric region from east-south-east to west-north-west of Cawsand. If that should be the explanation, the only treatment I can see would be distribution by one of the alternative methods (by wire, for example). The unstable air condition might have been placed on the coast, over the estuary, or between Plymouth and North Hessary Tor, if the interference had not been identified as coming from the sea; if there is some possible stationary reflector in that direction, the effect might still be anywhere within that region, or all over it. Glider pilots observe large eddies with horizontal axes: would it be possible for such an eddy, carrying air from the surface of the sea wound into it like the jam in a swiss roll, to produce a radio mirage in the direction opposite to that of the transmitters?

Forgive this fireside hypothesizing: it is so much easier than going out and investigating the problem properly!

London, S.E.18.

N. F. SHEPPARD.

The Fletcher-Munson Curves

P. WILSON states (March issue) that the Fletcher-Munson hearing curves¹ are not reliable in the case of complex tones. But who says they are intended to be? For pure tones under the given conditions all the evidence points to the accuracy of the curves, but pure tones do not exist in practice. When a pure tone stimulus is at a low level, it excites a few nerve endings within a limited region of the basilar membrane. As the frequency is changed, the point of stimulation moves along the membrane. If the sound has more than one frequency component, it excites more than one region of the basilar membrane. The loudness of the combination of tones is obtained by summing up the loudness values which would result from each of the tones acting alone. If, however, the regions of excitation overlap the problem is more complex and a simple summation alone will not give an accurate answer^{1, 2}. The effect of a complex tone is to produce an apparently louder sound from the same energy, thus the Fletcher-Munson curves flatten out.

It is also known that the loudness of a sound does not instantaneously reach a maximum. Therefore the apparent effect is much influenced by the rate of growth of the sound³. The apparent loudness is also influenced by the degree of consonance or dissonance of the sound, the latter always producing the effect of an increase in loudness^{4, 5}.

It will be observed from the references below that these investigations are by no means new, and Fletcher and Munson themselves were amongst the first to recognize the inadequacy of pure tone measurements for the assessment of musical sounds.

Nottingham.

ALAN DOUGLAS.

¹ H. Fletcher and W. A. Munson: Loudness; Its Definition, Measurement and Calculation. *J.A.S.A.*, 5 (1933) 82.

² D. H. Howes: The Loudness of Multicomponent Tones. *Am. J. Physics*, 63 (1950) 1.

³ G. von Béséký: Zur Theorie des Horens. *Physik Zeit*, 30 (1929) 115.

⁴ R. C. Mates and R. L. Miller: Phase Effects in Monaural Perception. *J.A.S.A.*, 19 (1947) 180.

⁵ G. von Béséký: Über akustische Rauigkeit. *Z. Tech. Physik*, 16 (1935) 276.

"Ionosphere Review, 1956": A Correction.—Owing to an unfortunate sub-editing error the words "sunspot number" appeared in line 15, left-hand column, page 146, in the March (1957) issue in place of "critical frequencies and m.u.f.s."

Semi-conductors in Waveguides for switching purposes are not so well known as ferrites (see December, 1956, issue, p. 595). It seems, however, that they may have certain advantages—one being the relatively insignificant power required for switching, even at high repetition rates. The development of a high-speed semi-conductor switch for the 3-cm band is mentioned by M. A. Armistead, E. G. Spencer and R. D. Hatcher in the December, 1956, issue of *Proc.I.R.E.* It consists of an *n*-type germanium diode mounted in the centre of the waveguide, and the r.f. impedance for switching is altered by varying the bias voltage as shown in the graph. The curves are for r.f. powers of 1mW or less, and the switching isolation is somewhat less for higher powers. The greatest isolation is actually obtained when the resistive and reactive com-

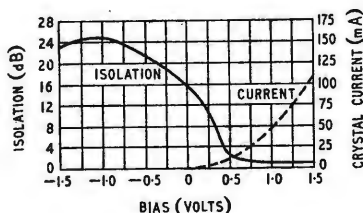

ponents of the diode r.f. impedance are near zero. Then 80 per cent of the energy is reflected, 0.3 per cent is transmitted and the remainder is absorbed in the diode.

"Thermionized," as distinct from "transistorized" might be applied to transistor equipments which have been fitted with thermionic valves. Recently some r.f. valves for use with h.t. supplies of only a few volts (for example a 12-V accumulator) have been introduced in this country by Brimar. Where r.f. transistors are not available, these valves can be used in the r.f. stages of transistor receivers without the necessity for an additional high-voltage supply. One of these valves is a tetrode employing the space-charge grid principle first described by Langmuir in 1913. By providing the grid next to the cathode with a positive accelerating potential (the usual control grid lying between this and the anode) useful current outputs at low voltages can be obtained. Secondary emission from the anode, which produced the dynatron kink in early tetrodes, is avoided here by the use of special materials and processing.

V.H.F. Transistor, with an oscillating frequency claimed to be more than 250 Mc/s, is now available in quantity on the American market. It is made by Texas Instruments, using an improved production technique in which a process of diffusing impurities into the crystal to give an extremely narrow base layer is com-

Technical Notebook

bined with the normal method of growing the crystal. The device makes possible transistorization of television and v.h.f. receivers, as well as increased speed in transistor switching circuits. Even higher frequencies than this have been reached in the experimental transistors made by the diffusion process by Bell Telephones. Here, diffused layers of less than one micron in thickness have made possible alpha cut-off frequencies in the region of 400-600 Mc/s. Obviously we may soon have to revise our original ideas about the transistor not being able to supersede the valve in all applications!

Control Knob Design for easy identification by touch so that mistakes in operation of equipment are reduced. Experiments on different shapes are described by D. P. Hunt and D. R. Craig in a D.S.I.R. unpublished report (PB11690).

Digital Indication is becoming popular for electronic measuring instruments, as well as in the industrial sphere, because of the ease and rapidity with which readings can be made and the reduction of possible ambiguities. It is particularly

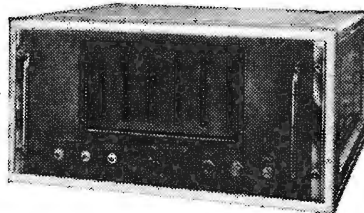

applicable in the field of time and frequency measurement, and the illustration shows a typical modern instrument (made by Racal) which can be used for both. When operated as an electronic chronometer, the start and stop pulses representing the time interval to be measured are used to gate a crystal-controlled 1-Mc/s oscillator. The cycles, each representing a 1- μ sec interval, are then counted over this period by a series of scale-of-ten circuits, and the result is indicated directly in microseconds on the six illuminated numerical scales. If the instrument is used for frequency measurement the internal oscillator is not required, and the scale-of-ten circuits simply

count the cycles of the frequency over a known time interval. To extend the range of measurement above the 1 second possible on the scales, an additional mechanical register is necessary.

"Supermandur." An improved grade of the "soft" magnetic alloy Permandur has been developed by Bell Telephone Laboratories. It is called "Supermandur" and, although of similar composition to Permandur (49 per cent iron cobalt, 2½ vanadium), is made from materials of high chemical purity in a controlled atmosphere furnace, and is subsequently heat-treated in a magnetic field. Saturation is at 24,000 gauss and maximum permeability is 66,000 at 20,000 gauss; hysteresis loss is 6 watts/lb at 100,000 lines/in² and 400 c/s. With "Supermandur" a 30 per cent reduction is possible in the size and weight of power transformers, compared with grain-oriented silicon steel. The material is ductile and laminations as thin as 0.0003in can be rolled. The hysteresis loop is rectangular, with a range of flux of 45,500 gauss from remanence in one state to saturation in the opposite direction. The steepness of the loop sides gives an increase of gain in magnetic amplifiers of 80 per cent over grain-oriented silicon steel.

Ceramic Valve Envelopes are now coming into wider use, especially for power valves. They give greater mechanical strength, smaller size for a given power dissipation, enable the

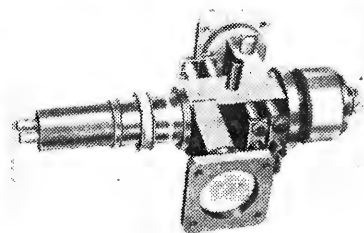

valves to work at higher ambient temperatures and permit more effective de-gassing during manufacture so that greater emission current can be obtained. A recent example is a 2-kW continuous-power klystron made by Varian Associates of Palo Alto, California. Working in the range 7,125-8,500 Mc/s, it has a per-

formance characteristic that permits amplification of modulated signals at power gains as high as 50 dB. Other advantages claimed by the makers are long life, ruggedness and low microphonics. The klystron is tunable ± 25 Mc/s from the centre frequency.

Transistor Batteries.—The cost of running battery-operated transistor equipment is becoming of some interest now that transistorized portable receivers, amplifiers and record players are arriving on the scene. As a guide, one battery manufacturer (Ever Ready) has compiled the table below giving an idea of costs and also service lives for various sizes of batteries. The figures are based on fixed resistance tests carried out for 4 hours per day, 7 days per week, to a final voltage of 1 volt per cell on load.

Drain (mA)	Test R (Ω)	Life (hrs)	Pence/hour
6V	25	600	0.08
	50	240	0.24
	50	120	0.65
9V	2	4500	0.3
	4	2250	0.75
	8	1125	2.36
9V	7	1285	0.27
	10	900	0.40
	25	360	1.50
9V	5	1800	0.09
	10	900	0.22
	20	450	0.53
6V	20	300	0.13
	50	120	0.32
	100	60	0.74
9V	10	900	0.10
	25	360	0.30
	50	180	0.82

Fixed resistance tests do not, of course, reproduce exactly the conditions of use, but at least they give a useful general guide.

Accelerated Valve Ageing for reducing the time required for life-testing valves. The effect of cycling and other expedients is considered by N. J. Reitz, R. P. Anderson, R. D. Guild and C. F. Douglas in a D.S.I.R. report (PB116411).

Tactile "Telephony" is under investigation, not only for deaf people but as a means of communicating with aircraft pilots during the critical take-off and landing periods when their other senses are fully occupied to the point of saturation. The basic idea is to apply stimuli to the five fingers of the subject by means of sensitive vibrating diaphragms, using a signalling code of different frequencies. In an aircraft, for example, these diaphragms—adapted for transmitting as well as receiving—could be incorporated in the control column. The graph shows the skin's sensitivity to vibration at different frequencies. According to J. Hirsch, writing in *I.R.E. Transactions* PGME-7 for December

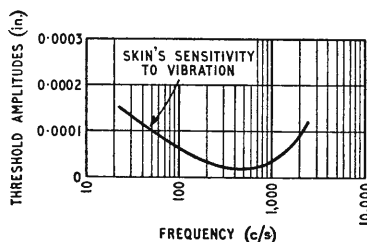

1956, tactual discrimination between frequencies is quite good. With practice, it is possible to recognize the difference between, say, 400 c/s and 420 c/s. It is interesting to note that the vibration curve looks rather like an auditory threshold curve, but is displaced towards the lower frequencies. An experimental device is being developed by the Commonwealth Engineering Company of Dayton, Ohio, for sending directional information to pilots through tactual signals applied to the thumb.

Smoother Response for low frequency horn-loaded loudspeakers is

COMMERCIAL LITERATURE

Low Leakage Electrolytic Condensers with values ranging from 0.5 to 50 μ F are described in a leaflet from T.C.C., North Acton, London, W.3. An insulation resistance of 100 $M\Omega/\mu$ F is attained after only three minutes of applied working voltage and this rises rapidly to 10,000 $M\Omega/\mu$ F if the condenser is left in circuit. These high resistances are maintained even after a six months' idling period.

T.V. Tube Construction in stages following the initial glasswork is shown in a copiously illustrated booklet from Mullard, Torrington Place, London, W.C.1. Physical and electrical tests include a test to show performance under possible conditions of low mains voltage.

Data on Brimar Valves including special-quality and CV types, transistors, thyratrons and hermetic seals are given in a booklet from Standard Telephones and Cables, Footscray, Sidcup, Kent.

Full Range of Microphones from the German Labor Company, to be marketed in England by G-A Distributors, 29, Whitehall, London, S.W.1, are described in a leaflet. Included is a microphone with a very directional response for use under noisy conditions, and a probe microphone for acoustic measurements. Earphones, microphone transformers, power amplifiers (up to 80 watts at less than 5% distortion), valve-voltmeters and other test instruments are also included.

Standard Oscillator and Signal Generator are described in leaflets from Airmec, High Wycombe, Bucks. The oscillator is variable from 100 kc/s to 1 Mc/s with a stability which improves with use up to one part in 10^7 . A temperature controlled 100 kc/s crystal is used. The signal generator covers

offered by a method discussed by W. E. Glenn in the December, 1956, issue of the *I.R.E. Transactions on Audio*. The horn is suitably plugged with sound-absorbing material. This material, by its resistive and reactive effects, compensates for acoustic mismatch and consequent reflections due to finite horn size. Another possibility is that, by using more than one plug, sharper h.f. cut-offs can be obtained. This avoids partial propagation outside the designed frequency range for the horn.

Transistor Wrist Receiver using three transistors and tuning over 1-1.6Mc/s with a sensitivity of 50 μ V. A D.S.I.R. unpublished report by the U.S. Signal Corps Engineering Laboratories (PB111461).

Unpublished Reports mentioned above come from various sources but can be obtained from the Technical Information and Documents Unit of the Department of Scientific and Industrial Research, 15, Regent Street, London, S.W.1.

30 kc/s to 30 Mc/s and includes crystal calibrator. The output is stabilized to ± 1 dB with harmonic distortion less than 1%. Continuously variable attenuation up to 120 dB is provided. The normal maximum output is 1 volt from a 75-ohm source, when the 1,000 c/s internal modulation is used.

Wide Variety of Industrial Electronic Equipment is illustrated in a booklet from Lancashire Dynamo Electronic Products, St. Stephens House, Victoria Embankment, London, S.W.1. These include electronically adjusting speed drives up to 10 h.p., voltage (to within 0.1%) and frequency regulators, a smoke alarm indicator and other photoelectric apparatus, welding equipment and various safety relays.

Flexible Terminal Strips are useful with curved surfaces or irregular spaces. A new product in moulded Wybac P.V.C. has a flashover voltage between terminals of 9 kV, the insulation resistance being greater than 10^{12} ohms. The blocks can also be cut with a knife. Leaflet from Precision Components, 13, Byng Road, Barnet, Herts.

Complete "Avantic" Sound Reproducing System includes record player, tape reproducer, a.m./f.m. radio feeder unit and cabinet. The loudspeaker system comprises a 12in bass unit and two 2½in treble units. The amplifier gives a maximum power of 27 watts with 0.1% total harmonic distortion. The pre-amplifier has a maximum sensitivity of 2 mV (45 dB signal to noise ratio) with a choice of eight inputs. It incorporates a fixed "rumble" filter cutting off at 40 c/s. The usual bass and treble controls are included, and there is choice of two treble steep-cut filters and a variable loudness control. Booklet from Beam-Echo, Witham, Essex. The units may be bought separately.

V.H.F. Variable Attenuators

LADDER-RESISTIVE ELEMENTS OF
CARBON COATED INSULATING MATERIAL

By B. G. MARTINDILL*

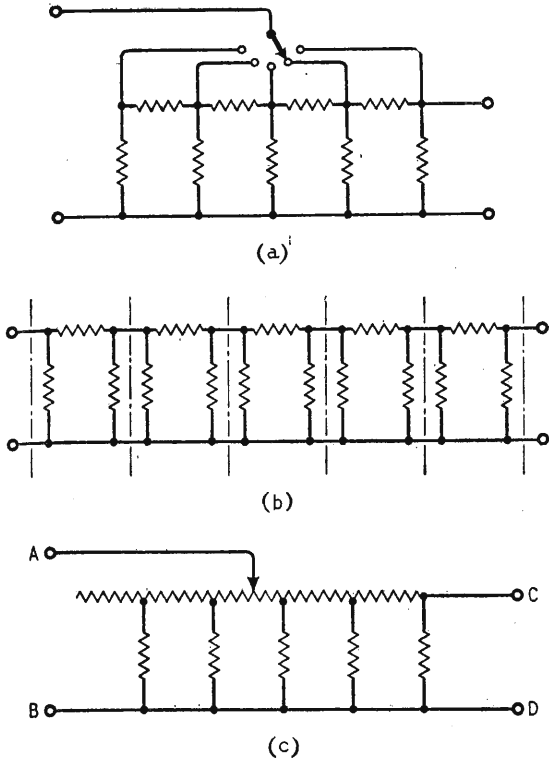

Fig. 1. Three forms of simple attenuators; (a) typical step type, (b) broken down into individual sections and (c) continuously variable ladder network.

IN designing variable attenuators for use at v.h.f. difficulty is experienced in maintaining the correct image impedance regardless of frequency. The ideal network would be one that is purely resistive and at the same time continuously variable and there are various ways that may be considered as reasonably approaching these requirements, but nearly all give rise to complicated mechanical arrangements which would prove costly to manufacture.

One of the simplest forms of attenuator of the unbalanced type is the T or π section, but to make these continuously variable would necessitate a ganged arrangement whereby the three resistive elements could be adjusted simultaneously. A further complication is that, to produce a linear calibration curve, it is necessary for the resistive elements to follow a logarithmic law.

Variable attenuators of the step type are in common use and usually comprise a number of T or π sections joined together in series, arrangements being made to tap into each section by a switch or other suitable means. (See Fig. 1(a).) Fig. 1(b) shows a step or ladder attenuator broken down into individual π sections, from which it will clearly be seen that the shunt resistors, with the exception of those at either end, are in parallel and may therefore be replaced by a single resistor of half the value.

If the number of π sections is made large then the incremental steps will be small, and if instead of a step arrangement a sliding contact is made to traverse the top of the ladder, as illustrated in Fig. 1(c), then we have a continuously variable attenuator with an almost linear characteristic. A simple and known form of this is an ordinary wire-wound potentiometer to which suitable shunt resistors are connected at regular intervals so that a ladder arrangement results. This form of ladder attenuator would not be of any use at anything except the very low frequencies owing to the high inductive reactance introduced by the wire-wound section.

A successful design which overcomes this difficulty (and is the subject of a patent application) is to manufacture the complete ladder attenuator as a press stamping from a thin insulating base which is covered with a thin carbon coating in a

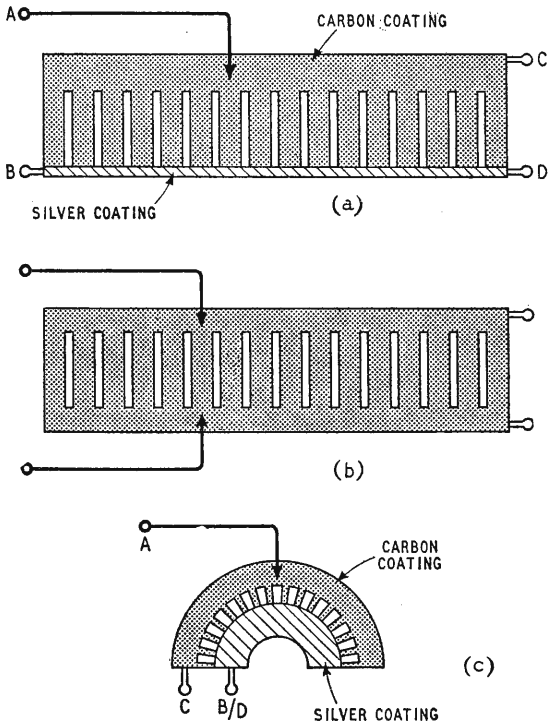

Fig. 2. Attenuators made from thin stamped out carbon-coated insulating material; (a) ladder network with single wiper, (b) balanced attenuator with ganged wipers and (c) semi-circular plate with rotating wiper.

* Wolsey Television Ltd.

similar manner to that normally used to produce carbon tracks for potentiometers. Such a method offers several advantages, chief of which is its low cost and ease of production in large quantities with identical characteristics.

Some of the possible variations are shown in Fig. 2, in which (a) is an unbalanced straight ladder section having fifteen identical sections. The lower portion is silver coated to provide the "earthy" side, the upper portion being the track over which the sliding contact operates, the shunt resistors being produced by punching out the slots. Fig. 2(b) is a similar network but is balanced. Balanced types would, of course, require ganged wipers.

Fig. 2(c) is another unbalanced type but of semi-circular construction on which it is possible to use a rotating wiper. Fig. 2(b) could be bent round a circular former to give a balanced rotary type.

When the carbon coating is uniform, and its specific resistance is known, the design of the unit becomes a simple process of calculating length and width of each section so as to give the required resistance value, and a press tool can then be made to stamp out the track to these dimensions.

Limits in physical size, in degree of accuracy and in total amount of attenuation are extremely wide, the ultimate accuracy being dependent upon the uniformity of the resistance of the carbon coating, and the closest possible limits in the stamping operation.

The types of track illustrated are symmetrical, the image impedance being the same when measured from either end; this could very easily be made to match unequal generator and load im-

pedances by making the end π section asymmetrical; this section would, of course, have to remain in circuit at all times and would dictate the minimum value of attenuation possible.

Though illustrated as linear arrangements there would be very little difficulty in designing these networks to follow any known law. In addition, several attenuators could be arranged in cascade, for example, by using three attenuators in cascade, each one comprising ten equal π sections, the first having a total attenuation of 1 dB, the second 10 dB and the third 100 dB, a constantly variable attenuation of up to 111 dB would be possible with an accuracy of better than 0.1 dB over this range.

Experiments carried out on frequencies up to 200 Mc/s show that the image impedance may be maintained to a very close tolerance. Careful design of the unit as a whole is essential to ensure that any stray capacitive effects between the track and any associated component or their mountings is kept to an absolute minimum.

No details are yet available on the operation of these units at frequencies higher than 200 Mc/s, but it is felt that careful design, with the possible introduction of electrostatic screening between the shunt resistance sections if found necessary (which could be easily achieved by screens located through the slots punched in the track to form these resistances), satisfactory operation at much higher frequencies could be realized.

These notes illustrate some of the more obvious ways in which such a network could be used and the author feels sure that the reader will visualize many other possible applications.

SCHOOL TELEVISION : APPROVED RECEIVERS

THIS year will see the introduction of school television in this country if plans now being made come to fruition. About 18 months ago the School Broadcasting Council announced that an experimental service of school television will be provided in the autumn. These transmissions will be radiated from all B.B.C. stations. Since then, the I.T.A. has announced that the first of a series of experimental transmissions for schools will begin on May 13th from London and Lichfield.

In order to give local education authorities reliable information on the suitability of receivers for classroom use, a series of tests was held toward the end of last year at a school in Hertfordshire. All manufacturers of television receivers were invited to submit equipment, and fifteen makers submitted twenty-four models. The tests were conducted in the presence of an appointed panel consisting of representatives of various educational authorities. The ten-page report of this viewing panel, recently issued by the Association of Education Committees (10, Queen Anne Street, London, W.1), includes as appendices notes on arrangements of classroom seating and a list of 16 receivers approved as suitable for classroom use (see table).

All three types of receiver—direct viewing, rear and front projection—were tested by the panel, but no front projection receiver was considered suitable. Two rear projection sets, each giving a 30-inch diagonal picture, are approved. With only one exception all the direct viewing receivers have 21-inch tubes. It is not recommended that smaller tubes should be used, and the panel expresses the hope that receivers with larger tubes will become available.

In the section of the report dealing with the *pros*

and *cons* of direct viewing and projection receivers it is stated that "the direct viewing receiver, though it gives a smaller picture, has some distinct advantages. The picture is brighter. The definition is better. There is less need to reduce the level of general room lighting. The picture does not deteriorate appreciably as one increases the angle to the screen. . . . On the other hand, care has to be taken to avoid reflections on the screen."

The majority of the receivers approved are standard production chassis housed in special cabinets with a viewing hood to reduce ambient light.

The question of maintenance was considered by the panel, and the manufacturers of all approved receivers have stated that they or their agents will contract to maintain the equipment.

Approved School TV Receivers Direct viewing

Bush Radio Model 281
Clarke & Smith Mfg. (Wallington) Model SB/DV2A
Cossor Models 904 and 905 (24-in tube)
Ekco Model ST304
Ferguson Model 4227/ST
G.E.C. Models BT3251S and BT93435
H.M.V. Models 1847 and 1848
Murphy Models V290CA and V300C
Philips Model 2160U
Wired Radio Service (Cheshington) Model CA21.3

Rear projection

Ferguson Model 4229ST
Wired Radio Service Model CA30.3

Colour TV on Tape

By H. R. L. LAMONT*, M.A., Ph.D.

ACCURATE SERVO CONTROL OF HIGH-SPEED TAPE MOTION

IN December, 1953, the RCA Laboratories at Princeton, U.S.A., demonstrated a system for recording and reproducing colour television signals on magnetic tape^(1, 2). The equipment was experimental and some problems remained to be solved.

Since then new equipment involving major improvements has been built and installed in the studios of the National Broadcasting Company in New York. This equipment will handle both colour and monochrome signals, but the basic requirement was for a system to handle colour signals. This done, the much less stringent requirements of a black-and-white signal are met almost automatically.

In colour television operations the camera contains three pick-up tubes which provide red, green and blue signals. These three signals are processed by an encoder to provide the composite colour television signal which is radiated. This signal is decoded by the receiver into its original red, green and blue components.

In the recording of a colour signal on magnetic tape the same basic principle is used—the composite signal is decoded into its red, green, and blue video components, together with the audio signals, and these are recorded on separate parallel channels on the tape. On reproduction the process is reversed.

A basic problem is the wide frequency band involved—up to about 3.5 Mc/s. In conventional

*Radio Corporation of America, European Technical Representative. This article is condensed from a lecture given to the British Kinematograph Society. It is based on a series of papers by H. F. Olson, W. D. Houghton, A. R. Morgan, M. Artzt, J. A. Zenel and J. G. Woodward, published in the *RCA Review*, Vol. 17, pp. 330-392, 1956, under the title "A Magnetic Tape System for Recording and Reproducing Standard F.C.C. Colour Television Signals" in which the development and construction of the equipment is treated in much greater detail.

audio tape recorders the upper frequency limit, for a given tape speed, is determined primarily by the resolving capabilities of the magnetic head, which is about 2,000 cycles per lineal inch of tape. Thus a tape speed of about 8 inches per second is required for a 16-kc/s response. To record frequencies up to 3 Mc/s should require a tape speed 200 times greater—133 feet per second—but a magnetic head has been designed for this equipment with sufficient resolving ability that a tape speed of only 20 feet per second is required.

It is found that, for this tape speed, the maximum output from the magnetic head is obtained when the recording signal current is maintained constant with frequency, and the bias current is raised as an approximate inverse function of frequency. A usable frequency characteristic is obtained by dividing the range into two parts, a constant d.c. bias of 2 mA being used between 400 c/s and 1.5 Mc/s, and a zero bias above 1.5 Mc/s.

This splitting of the frequency range has been combined with the "mixed highs" principle of colour television⁽³⁾. Thus the red, green and blue signals are recorded with a bandwidth of 1.5 Mc/s on three parallel tracks on the tape, while the frequency components of the three colour signals between 1.5 and 3.5 Mc/s are mixed and recorded on the tape as a fourth "mixed highs" channel. Line synchronizing signals are recorded on a fifth channel. A quintuple head and half-inch-wide tape are used, with the track layout shown in Fig. 1. The two audio channels are recorded by a separate head.

Fig. 2 shows schematically the arrangement for recording standard F.C.C. colour television signals. The signal is first fed to a decoder unit which recovers the three primary colour components and the audio and synchronizing pulses, and these are applied to the tape heads as already described.

A major problem is the signal distortion resulting from irregularities of tape motion. This distortion is usually observed as a horizontal motion of, or in, the reproduced television picture. If the tape motion irregularities occur slowly, the picture will move as a whole; if the irregularities occur rapidly a waviness appears within the picture. In the equipment design great pains were taken to reduce these irregularities to a minimum.

The same tape transport mechanism operates both

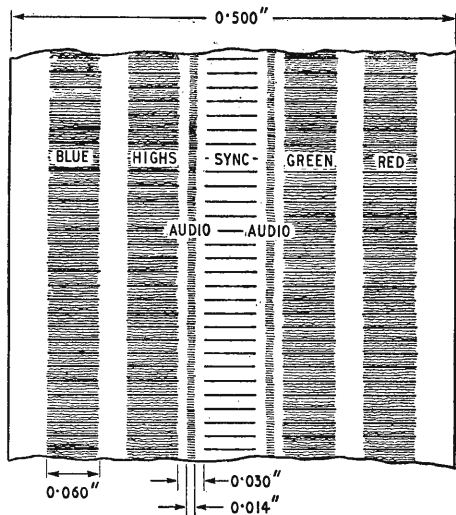

Fig. 1. Track layout on magnetic tape.

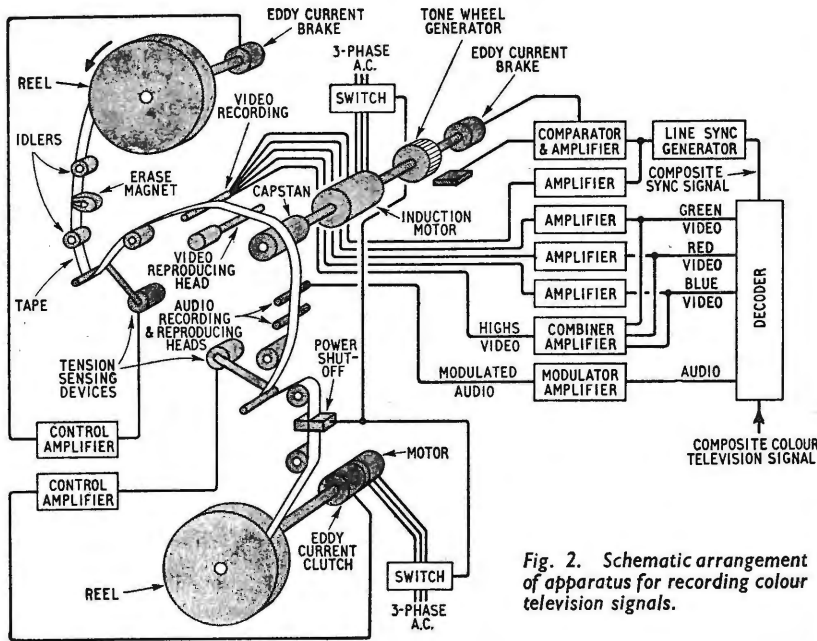

Fig. 2. Schematic arrangement of apparatus for recording colour television signals.

for recording and reproduction, and performs two basic functions. The first is that of maintaining constant tape velocity during recording so that the video signals are properly recorded on the tape. The second is that of controlling tape velocity during reproduction so as to maintain coincidence between the synchronizing signal reproduced from the tape and the signal produced from a local sync generator. It might seem that, having all the signal components recorded on the tape, it would be a relatively simple task to reproduce a composite television signal by connecting these component signals to the inputs of a standard encoder, but this is not so. The reason is that, in providing the complete composite signal, the encoder must supply a colour sub-carrier, a synchronizing burst, line drive, and synchronizing pulses, all of which must satisfy the extremely stringent specifications imposed by the F.C.C. Colour television broadcasting meets these requirements because the timing of all signals is under the direct control of a common synchronizing generator. The use of a sync generator which controls the tape velocity rather than being controlled by it is thus an essential in the system. Then any undesired variations in tape speed cannot affect the colour saturation, hue, or burst stability; instead, they will result only in a horizontal movement of the reproduced picture within the scanning raster.

It is interesting to compare the performance required with that of commercial photographic motion picture equipment. It has been shown⁽⁴⁾ that the effective horizontal frame displacement of a 16-mm film corresponds to approximately $\pm 1\frac{1}{2}$ in on a 21-inch television picture. This corresponds approximately to a $\pm 0.2\mu\text{sec}$ displacement of the line synchronizing pulses, or to a tape displacement of $\pm 50 \times 10^{-6}$ inch. In sound recording language this represents a "wow" of approximately 0.004 per cent. This is at least an order of magnitude beyond the accepted performance of professional sound recording equipment.

In considering the tape transport when used for reproducing it is important to realize that a constant speed mechanism is not sufficient. The recorded tape will contain irregularities which require a complementary motion of the tape if the reproduced pulses are to have the desired relationship to the pulses at the transmitting station. A servomechanism as in Fig. 3, in which the local synchronizing pulses are the input function and the reproduced synchronizing pulses are the output function, solves the problem in principle. The error detector determines the lack of coincidence between the two synchronizing signals, and this operates a speed controller in the form of an eddy-current brake.

To control the tape speed during recording, a signal is required which is indicative of any irregularity in speed. There appears to be no practical method by which the instantaneous speed of unrecorded tape can be determined with the desired accuracy. The best procedure is to control the speed of the capstan and accept whatever irregularities may occur between the capstan and the tape motion.

The necessary signal for indicating irregularities in the capstan speed is derived from a magnetic tone generator attached to the capstan shaft. With this addition and a few wiring changes the reproducing servomechanism becomes the recording servomechanism shown in Fig. 4.

The speed response of a servomechanism is usually limited mainly by the inertia of the moving

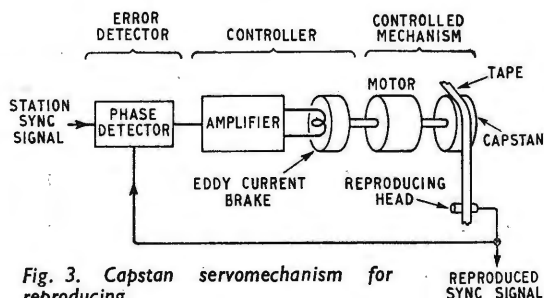

Fig. 3. Capstan servomechanism for reproducing.

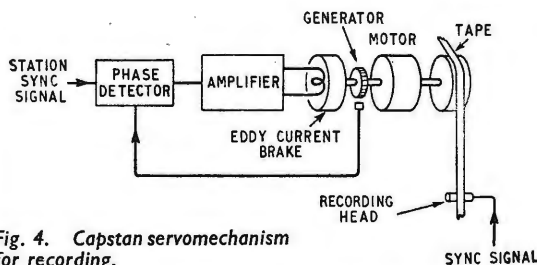

Fig. 4. Capstan servomechanism for recording.

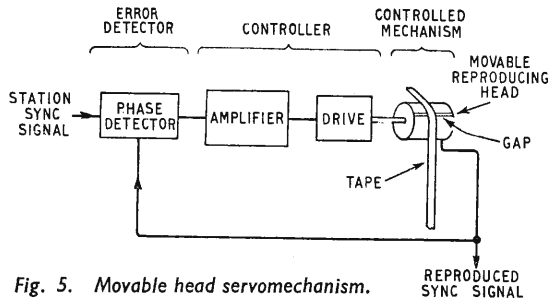

Fig. 5. Movable head servomechanism.

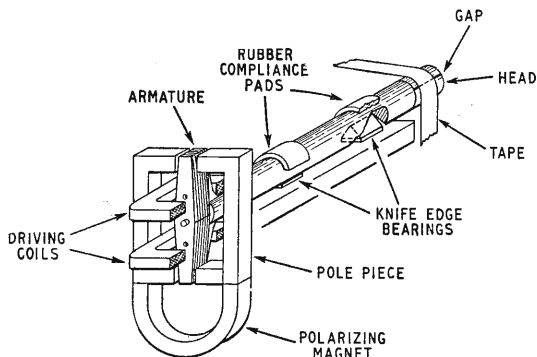

Fig. 6. Mechanical arrangement of movable head.

system, and here the capstan plus eddy-current brake have a relatively high moment of inertia. To overcome this limitation a further servomechanism with a much smaller moment of inertia is added, which is required to correct only the residual irregularities. This is achieved by making the reproducing head movable relative to the tape, as shown in Fig. 5. The head is cylindrical and the gaps are located on its periphery. Rotation of the head about its axis, over a small angle, thus gives the desired motion of the gap without disturbing the tape motion. The drive, shown in Fig. 6, is a balanced magnetic unit whose armature is connected to the magnetic head by a shaft pivoted on knife-edge bearings.

Fig. 7 shows the overall arrangement of the three servomechanisms. In the recording position (indicated by "R") the input signals are connected to the recording head, and the tone generator is connected into the tape transport system. In the reproducing position (indicated by "P") the capstan and moving head servomechanisms operate independently. To allow this the recording head, which in the reproducing position would normally be unused, is switched in to provide the reproduced synchronizing signal for the capstan servomechanism.

The mechanical design of the tape transport components calls for extreme attention to detail, and they demand the highest precision of workman-

ship to secure a smooth movement of the tape.

Despite the care taken in the design of the drive and synchronizing system, its effectiveness is still dependent on changes in tape tension and so these are minimized as far as possible.

The tape is unwound from a reel to which variable braking must be applied and, after passing over the capstan, is wound up on a motor-driven take-up reel. During the process the reels are slowly changing their speeds and also their weights and rotational energies. For a constant tension on the supply side of the capstan, the braking torque applied must be directly proportional to the radius of the tape roll at that instant. Likewise, the torque of the motor on the take-up reel must be directly proportional to the radius at any instant.

For control of tension the tape passes over a spring-biased sensing arm. A shutter attached to the arm partially obstructs the path between a light source and a photocell, as shown in Fig. 8. The photocell output current then varies with angular position of the sensing arm, providing an error signal indicating changes in tension. This error signal is applied to the current coils of the eddy-current brake or clutch, similar mechanisms and circuits being used both for braking the supply reel and for driving the take-up reel. For the supply reel, the stator windings are held stationary, and the eddy-current cup acts as a brake. For take-up motion, the stator windings are motor driven in the same direction as the tape so that the eddy-current cup acts as a clutch to supply the variable take-up torque.

With this system the tape tension is maintained constant within less than 1 per cent over the entire speed range of the reels. The sensing arms also provide the resilience between the reels and the capstan which is necessary under starting and other transient conditions.

On starting, about six seconds are required for all servos to settle down to normal running conditions. To avoid undue complication only line synchronizing pulses are recorded, and frame synchronizing is therefore a manual adjustment. Frame coincidence, once established, will of course be maintained by line coincidence. The time taken to establish framing is partly dependent on the skill of the

Fig. 7. Schematic arrangement of servomechanisms for recording (R) and reproducing (P).

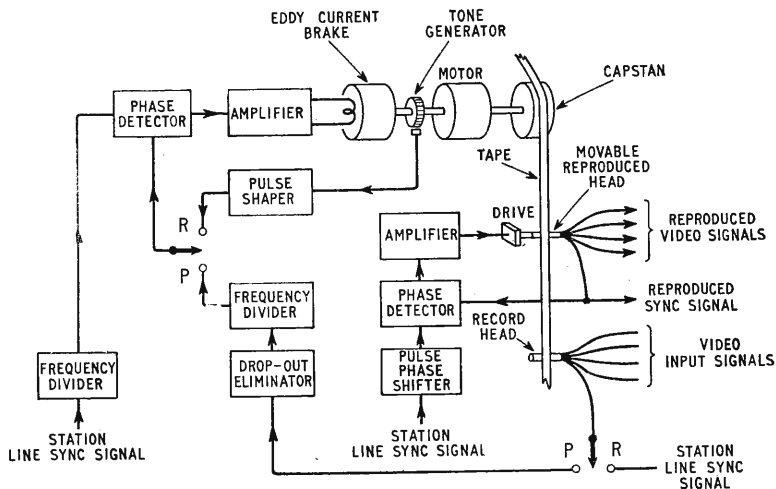

operator, but is usually about a further eight or nine seconds.

The tape reels used are 20 inches in diameter, and they rotate at about 230 r.p.m. when full, 540 r.p.m. when empty. With a tape of the standard 0.0015-inch thickness the playing time would be only eight minutes, but the advent of a new material called Mylar allowed 0.0075-inch thick tape to be used, which gives a playing time of 15 minutes per reel. This is adequate for most programme purposes.

In spite of the high speed, tape breakages almost never occur. Tapes stored for several months have shown no noticeable print-through, and a single tape can be erased and re-used at least 100 times without any perceptible deterioration.

Magnetic Head Design.—Under the conditions of operation the magnetic head must be capable of resolving between five and ten times as much per

lineal inch as a standard audio head, and must present a reasonable impedance up to 3.5 Mc/s. It was found possible to design a head having an extremely short gap structure, and Fig. 9 shows a cross-section of a single element of this unique head. A 200-turn coil is threaded on a magnetic core consisting of three 0.002-inch strips of Hymu 80, the ends of which are pressed and held together by two half-cylinders of stainless steel. The entire assembly is bonded together with a casting resin. When the two half-cylinders press the two ends of the core together the area of contact between these ends originally extends inwards to a depth of about 0.005-inch. These ends, which are the pole faces, are carefully cut down until the depth is about 0.001-inch. No separator is used, the pole faces being in intimate contact. Thus the "gap"—a non-magnetic spacer in conventional heads—is only a concept in this unit.

A complete head contains five of these basic elements in a length of just under $\frac{1}{2}$ -inch. Even though there are no shields between the separate elements the crosstalk between them is negligible.

In its present state of development this video head can record and reproduce more than 15,000 cycles per lineal inch. The upper frequency limit is about 3.5 Mc/s, at a tape speed of 20 feet per second, and the frequency response is as shown in Fig. 10. In curve A, which extends from about 400 c/s to 1.5 Mc/s, the bias and signal are adjusted for best response at 1,000 c/s. These are the conditions used for the red, green and blue channels. In curve B the bias and signal are adjusted for best response at 1 Mc/s. These are the adjustments used for the mixed highs channel, the bias in this case being less than 0.5 mA. A d.c. bias is used to linearize the operating characteristic, in contrast to the a.c. bias normally used in audio practice. Corresponding to this d.c. bias a d.c. erasure technique is also used, the tape passing over a strong permanent magnet before reaching the recording head.

Since there is no observable null in the frequency response curves, no positive statement about the gap width can be made. However, since the information density represented by the high end of curve B is about 15,000 cycles per lineal inch, the gap length can be deduced to be not greater than one wavelength, or about 7×10^{-5} inch. One horizontal line of the picture occupies a length of 0.015 inch on the tape.

The lives at present obtained with these heads are about 100 hours.

Audio Recording System.—The techniques for recording audio frequencies on tape are highly developed, and one might expect that the addition of an audio channel to the video recording system would be a routine matter. However, the special requirements of the video channels impose unusual conditions on the audio channel. In the first place the high tape speed is a disadvantage, since it gives a greatly increased output noise voltage without a comparable increase in audio signal. The two audio tracks give a total track width of 0.028 inch, which is considerably less than the $\frac{1}{8}$ -inch and $\frac{1}{4}$ -inch tracks normally employed. The effect of the narrower track is also to reduce the signal-to-noise ratio.

The two tracks are recorded by two identical head units connected in series, these being similar to the heads used in the video section. The recording and playback heads are located on the side of the driving

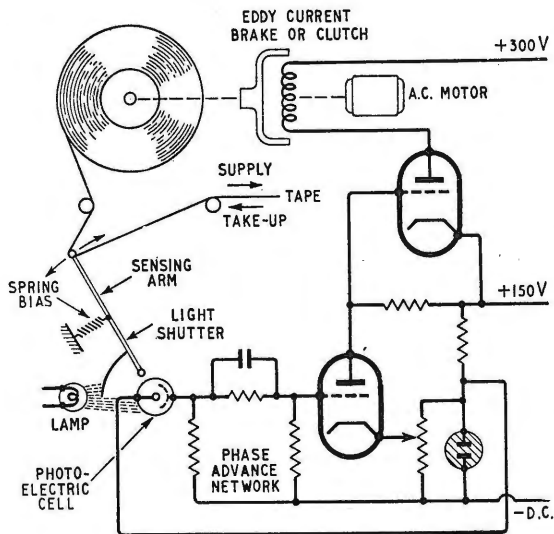

Fig. 8. Optical control of tape tension.

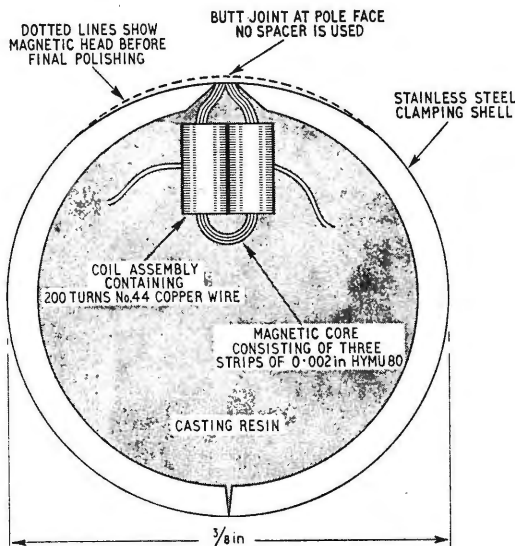

Fig. 9. Cross-section of magnetic head element.

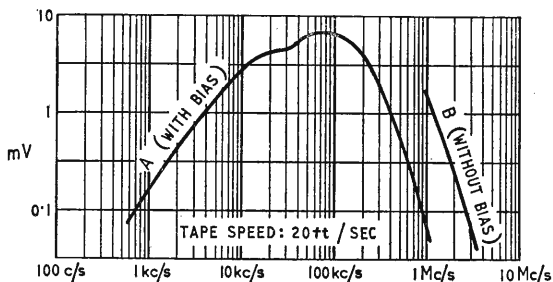

Fig. 10. Frequency response of video magnetic head.

capstan remote from the video heads. The 0.008-inch guard bands separating the audio from the video tracks are sufficient to prevent crosstalk.

Under these conditions conventional direct recording does not provide acceptable quality, so a method employing a frequency modulated carrier is used, with a mean carrier frequency of 90 kc/s and a deviation of ± 15 kc/s. The wide deviation permits a higher signal-to-noise ratio, and is determined by the range over which adequate linearity of circuits can be maintained, rather than by the available bandwidth. Under these conditions the maximum signal-to-noise ratio is limited by variations in tape speed. Any change in tape speed causes a corresponding change in carrier frequency, which results in a noise voltage at the demodulator output. The tape speed at the audio heads varies less than 0.025 per cent (this is without the benefit of the movable head as used for video reproduction), and with this a satisfactory signal-to-noise ratio is obtained.

Performance.—The result of irregularities in the tape motion is seen in practice as a waviness in the vertical lines of the picture. This waviness has been observed to range from barely perceptible to a peak-to-peak amplitude of approximately $\pm \frac{1}{8}$ inch. The amount of waviness is bound up with the slight

curvature often present in the tape. On occasions odd coating conditions appear to cause sticking between the tape and the magnetic heads, resulting in random waviness in the picture.

This equipment has been on field test at the National Broadcasting Company in New York since April, 1956. Television programmes originating in California and elsewhere are regularly recorded in New York, and recorded programmes have been put on the air experimentally. In October, 1956, the first on-the-air public showing of video tape, in both black-and-white and colour, was made by the N.B.C. over a coast-to-coast network.

Observers have agreed that, in its present state of development, the equipment will reproduce a television picture whose steadiness compares favourably with that of studio motion picture equipments.

It must be emphasized that the equipment is still in the development stage, and the figures given do not represent the ultimate possibilities. Under controlled conditions pictures have been recorded and reproduced with a bandwidth well over 4 Mc/s and with no perceptible jitter. Audio signals having a signal-to-noise ratio of 60 dB and undetectable distortion can be realized. When these results can be obtained under normal conditions the equipment will be ready to play an important part in the daily colour television programme activities.

REFERENCES

¹ H. F. Olson, W. D. Houghton, A. R. Morgan, J. Zenel, M. Artzt, J. G. Woodward and J. T. Fischer. "A System for Recording and Reproducing Television Signals," *RCA Review*, Vol. 15, p. 3, 1954.

² C. G. Mayer. "Recording Television and Sound Signals on Magnetic Tape," *Electronic Engng.*, Vol. 26, p. 292, 1954.

³ A. V. Bedford. "Mixed Highs in Colour Television," *Proc.I.R.E.*, Vol. 28, p. 1003, 1950.

⁴ A. C. Robertson. "Dimension of 16mm Film in Exchanges," *Jour.S.M.P.T.E.*, Vol. 57, p. 529, 1951.

SHORT-WAVE CONDITIONS

Prediction for April

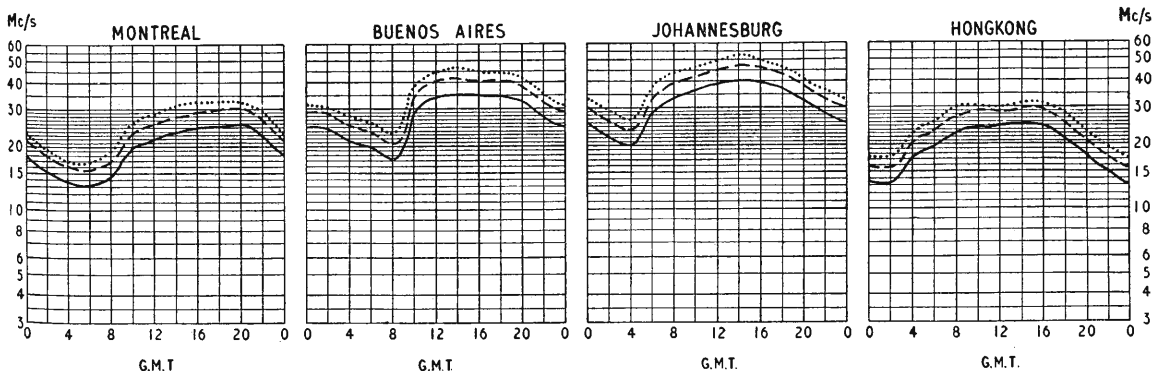

THE full curves given here indicate the highest frequencies likely to be usable at any time of the day or night for reliable communications over four long-distance paths from this country during April.

Broken-line curves give the highest frequencies that will sustain a partial service throughout the same period.

- FREQUENCY BELOW WHICH COMMUNICATION SHOULD BE POSSIBLE FOR 25% OF THE TOTAL TIME
- PREDICTED AVERAGE MAXIMUM USABLE FREQUENCY
- FREQUENCY BELOW WHICH COMMUNICATION SHOULD BE POSSIBLE ON ALL UNDISTURBED DAYS

Choosing Radar Wavelengths

Relative Performance of 10 and 25 cm for Surveillance Equipment

By R. F. HANSFORD* and R. T. H. COLLIS*, M.A., F.R.Met.S.

MODERN air traffic control systems designed to deal with high-density traffic are making more and more use of radar surveillance, either for monitoring or direct control. The increasing use of fast, high-flying aircraft calls for a radar with a long range and high altitude coverage that would have been beyond the bounds of possibility only a few years ago. The rapidly increasing number of small fighter aircraft presents the twin problems of greater danger to civil aircraft and worse detectability to the air traffic control radar. To provide safety in the air over the large regions for which the traffic control authority is responsible makes stringent demands upon the radar and the choice of suitable equipment becomes a problem requiring the most careful study. Military defence makes even more stringent demands on the long range surveillance radar. To control interception, bomber and fighter must be observed with absolute continuity.

These equipments must continue to perform their functions reliably in difficult terrain conditions or in adverse weather. This latter point in particular has led to considerable controversy as to whether 10 or 25 cm is the better operating wavelength for long-range surveillance. Indeed, it is probably one of the most controversial subjects in the whole field and it is perhaps for this reason that so little has been written on it. It is also a subject on which some serious misconceptions exist.

Coverage.—The basic detection range to be expected from a particular radar is a fundamental

problem governed by known mathematical relationships.¹ It may be expressed by the following equation:—

$$R_{max}^4 = \frac{PA^2f^2}{4\pi S_{min}\lambda^2} \times \sigma$$

- where
- R_{max} = maximum detection range
 - P = transmitter peak power
 - A = area of aerial
 - = an aerial illumination factor (which may be between 0.7 for a pencil beam and 0.2 for a cosecant¹ beam)
 - S_{min} = minimum detectable signal
 - λ = wavelength
 - σ = aircraft radar cross section (radar reflecting area).

It may be seen that if the wavelength is increased by a factor of 2.5, then to achieve the same detection range either the transmitter power must be increased 6.25 times or the area of the aerial must be increased 2.5 times. The extra cost and complexity of these increases must be taken into account in deciding the operating wavelength. So far as the minimum detectable signal S_{min} is concerned there is not likely to be any great difference between 10- and 25-cm equipments. Receiver noise factors of 8 to 10 dB are now common in high-performance equipments at either wavelength and the other factors affecting S_{min} are not likely to differ greatly for equipments designed to fulfil the same purpose.

Assuming that the transmitter power and the aerial size for a radar are fixed by the limit of what is practicable, then it may be seen from the above equation that the detection range "R" will be proportional to $\sqrt{1/\lambda}$.

Taking some typical values of, say, one megawatt for the transmitter power, 50 square metres for the aerial (50 ft × 12 ft) and an aircraft of 20 square metres radar cross section (small transport), we may examine the comparative free space performance for similar 10- and 25-cm radars, the effect of ground reflections and adverse weather being

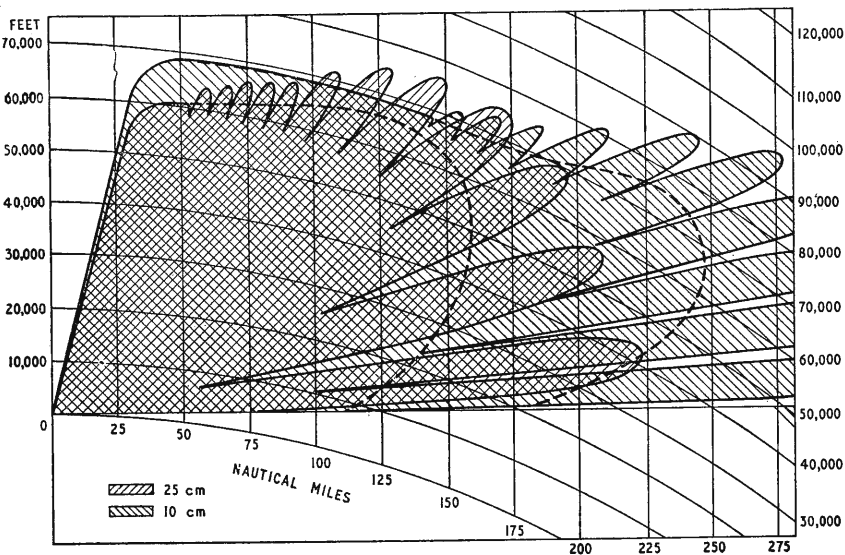

Fig. 1. Calculated coverages of 10- and 25-cm radars having same size of aerial for a large transport aircraft. Scanner height 25 ft.

dealt with below. The maximum range for such a 10-cm radar would be about 250 nautical miles and the range for a 25-cm radar having the same characteristics would be:—

$$250 \times \sqrt{\frac{1}{2.5}} = 158 \text{ miles}$$

It is now necessary to consider the effect of the energy radiated downward from the scanner and reflected from the ground. This energy interferes with the energy radiated directly from the scanner and can profoundly affect the coverage by partially breaking it up into a number of lobes; the presence of these lobes has advantages and drawbacks and it is therefore important to examine their nature.

The angle between the maxima and minima of the lobes is given approximately by the formula:—¹

$$\alpha = \frac{\lambda}{4h} \text{ radians}$$

where α = angle between a maximum and next minimum

λ = wavelength

h = aerial height above reflecting surface.

It may thus be seen that for a given aerial height, the lobe structure has a finer pattern on 10 cm than on 25 cm and that the lowest lobe will be closer to the ground at the shorter wavelength. The length of the lobes will depend on the strength of the upward and the downward radiation from the aerial and upon the reflection coefficient of the ground. If the upward and downward radiation of the aerial are equal and if the reflection coefficient is 1, then the maximum range of the lobes will be double that of the free space range. When this advantage is achieved, the drawback must be accepted that the gaps between the lobes reach right back to zero range and the coverage is therefore exceedingly broken. In practice, the lobe structure will lie somewhere between this extreme and the unbroken free-space pattern.

The fact that the coverage is dependent upon the ground reflection means that in practice it is likely to change markedly as the aerial rotates and from day to day as the ground changes from wet to dry. This broken and varying coverage makes it difficult to give a simple answer to the question of what is the maximum range of a given radar. The practice is becoming more common of regarding the useful range of a radar as that at which a given aircraft can be detected and tracked with a 90% probability, and this must allow for aircraft fluctuation as well as lobe structure. It is obvious that such probabilities cannot be achieved in the outer regions of the interference lobes; indeed the presence of interference is more likely to reduce rather than increase the range at which a 90% probability of detection will be achieved. For these reasons it is the aim of the designer of modern radar equipment to reduce the ground reflections as much as possible. This he can do (particularly in so far as the near-in reflections are concerned which cause gaps in the high altitude coverage) by achieving the sharpest possible cut-off to the bottom of the beam. This is much more

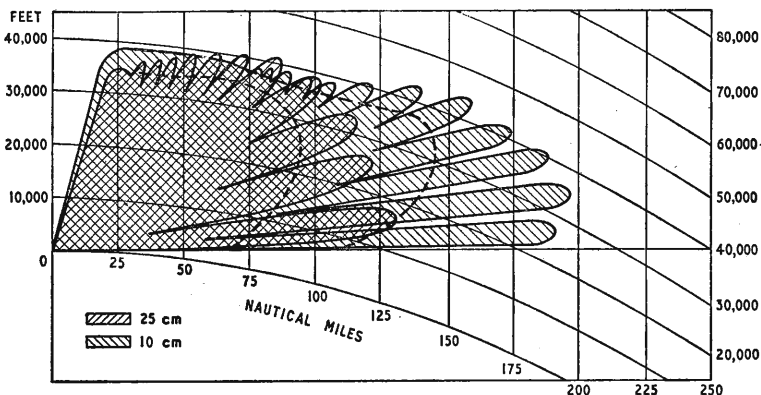

Fig. 2. Calculated coverages of 10- and 25-cm radars having same size of aerial for a small aircraft. Scanner height 25 ft.

readily achieved at 10 cm than at 25 cm, beamwidth being proportional to wavelength.

The calculated coverage of 10- and 25-cm radars both having aeriels of the same dimensions are given in Fig. 1 for a Viscount aircraft. A small fighter, which could provide a collision risk to a transport, may have only about one-tenth the radar reflecting area of a Viscount and it is important to consider the coverage and the gaps for such an aircraft; this is illustrated in Fig. 2. It is instructive to examine on each diagram the detection to be expected of both types of aircraft as they fly in at a given altitude.

A 10-cm equipment with an aerial width of 50ft has an effective bearing discrimination of about 0.5° corresponding to a little under 2 miles at 200 miles. A 25-cm radar having the same size of aerial would have a discrimination of about 1.3° corresponding to about 5 miles at 200 miles.

Ground Clutter.—The presence of houses, trees, hillsides and the like give rise to permanent echo clutter which can mask the presence of the wanted targets. This is generally a close-range problem and except in the case of unusually high radar sites, or in mountainous territory, seldom extends beyond some fifty miles. Within this range it can present a serious problem.

Assuming that a patch of ground clutter consists of a large number of individual objects and that this patch is larger than an area defined by the beamwidth and the pulse length, it may be shown that the relative echo strength of the clutter and a wanted target is given by the equation below (for the case when both target and clutter are substantially in the same part of the vertical beamwidth).

$$\frac{S_t}{S_{cg}} = \frac{\sigma W}{R\lambda\tau\sigma_{cg}}$$

where

- S_t = target echo power
- S_{cg} = ground clutter echo power
- W = width of aerial
- τ = pulse length in units of distance
- R = range
- σ_{cg} = clutter radar cross section per unit area

It will thus be seen that, other factors being equal, the target-to-clutter ratio will be 2.5 times better at 10 cm than at 25 cm. It is also of interest to note that any increase in aerial width or decrease in

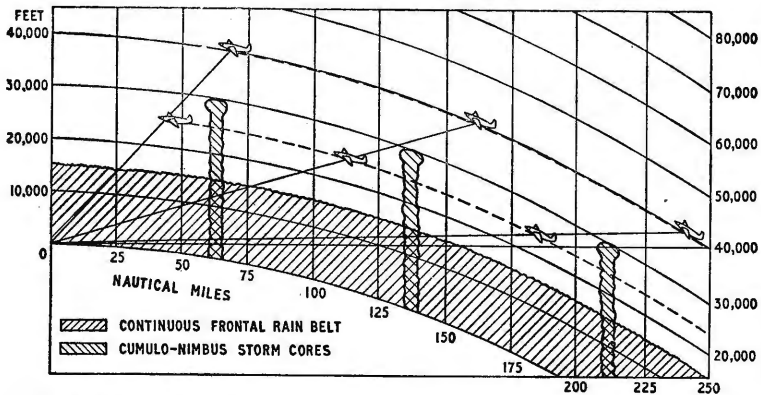

Fig. 3. Two different sets of meteorological conditions are shown here: a continuous rain belt extending up to 15,000 ft and isolated rain areas with cumulo-nimbus centres.

pulse length results in an improvement of target-to-clutter ratio.

In practice, it is usual for the radar beam to be elevated slightly above the horizontal and this will result in a decrease in the clutter amplitude, the target/clutter ratio depending upon the aircraft height above ground and the beam characteristics. Further, the sharper the bottom cut-off of the beam the smaller will be the clutter amplitude; thus the sharper elevation beamwidth usual with a 10-cm radar will also contribute toward an improved signal-to-clutter ratio at this wavelength.

The higher bearing discrimination provided by a 10-cm radar will result in the ground clutter area appearing more localized and more broken up. It is thus possible for wanted targets to be seen through the clutter more readily.

It will thus be seen that the 10-cm radar has an inherent advantage over the 25-cm one in target-to-ground-clutter ratio; advantage ratios of 6 to 12 dB are quite common for radars of the same dimensions. Nevertheless, it may well be that on both wavelengths the target echo is weaker than the clutter echo, particularly when the aircraft is flying well above the main beam. In such cases it may be necessary to resort to clutter suppression techniques, such as "moving target indication" (M.T.I.). In such systems the radar information is stored and then used to cancel the radar information obtained

a short interval of time later; thus echoes which have remained unchanged (the permanent echoes) will be cancelled whilst echoes which have changed their position (such as moving aircraft) will not be cancelled.

Currently available and well tried M.T.I. systems working on pulse-to-pulse storage¹ are readily constructed for 50- and 25-cm radars and it is not uncommon for aircraft to be detected in clutter 25- to 35-dB stronger. Such systems are more difficult to construct at 10-cm wavelengths and their stability and performance are poorer; there is also a reduction in performance due to the smaller number of pulses

per target obtained for the size of antenna considered here, and it is usual to expect sub-clutter visibilities of not more than some 10 to 15 dB. Newer forms of M.T.I. using rotation-to-rotation storage offer better sub-clutter visibility for the lower number of pulses per target common with high discrimination 10-cm equipments and sub-clutter visibility figures of the order of 20 dB are now possible.

On the subject of ground clutter performance it may thus be seen that an inherent advantage to 10-cm equipment of about 6 to 12 dB is offset by an M.T.I. performance which is likely to be worse by some 5 to 15 dB. There is thus basically little to choose between the two wavelengths in this respect: an individual 10-cm radar may have a better or worse clutter performance than an individual 25-cm one depending upon the actual characteristics of each.

Weather Effects.—Adverse weather conditions can effect the performance of the radar equipment in two ways:—

(a) the presence of rain can cause attenuation of the radar energy so that some of the energy passing through such weather conditions will be lost on its way to the target and back. Thus the echo from the wanted target will be weakened;

(b) some energy will be scattered back from the

(Continued on page 191)

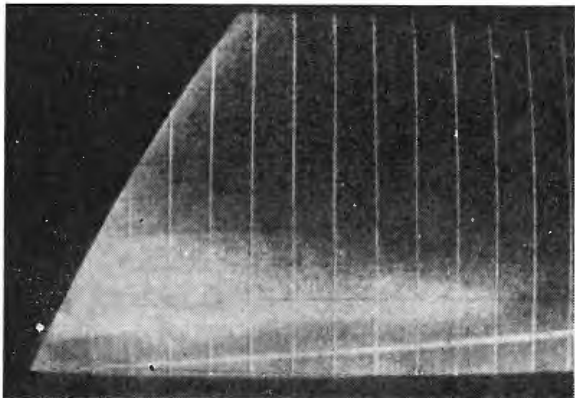

Fig. 4. Effect on typical range/height radar display of a continuous rain belt. (Courtesy Meteorological Office).

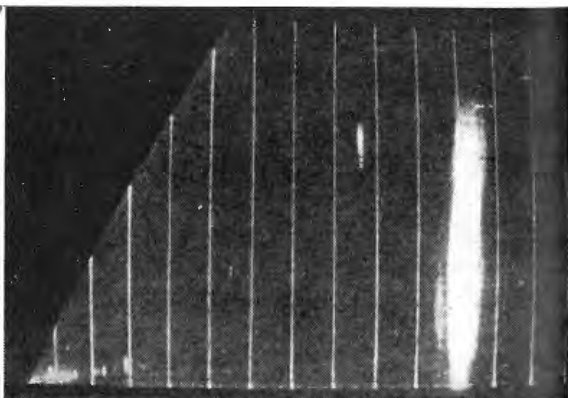

Fig. 5. Effect on typical range/height display of cumulo-nimbus cloud centre at about 7 miles. (Courtesy Meteorological Office.)

TABLE I

Rainfall Rate	Attenuation at 10 cm	Attenuation at 25 cm
10 mm/hr 25 mm/hr	0.006 dB/km 0.015 dB/km	0.001 dB/km 0.0025 dB/km

rain and will appear as clutter echoes upon the display. Such clutter echoes may mask the presence of a wanted target echo.

The importance of these two deleterious effects will now be examined. Fig. 3 shows two different sets of meteorological conditions, first of all the presence of a continuous belt of moderate intensity rain extending to a height of about 15,000 ft as in frontal or cyclonic rain; in temperate latitudes this may be taken as an extreme case, such rain not normally extending much above 10,000 ft. Also shown is the alternative situation of isolated thunder rain where the heavy centres of rain are associated with the cores of cumulo-nimbus clouds. It is particularly important to realize that in general, in temperate climates, continuous rain is of only light or moderate intensity (up to 10 mm/hr), whereas heavy rain (25 mm/hr) is of an isolated nature and of very short duration². The two different types of rainfall are well illustrated in Figs. 4 and 5, which are photographs of the range/height display of a meteorological radar; the isolated nature of cumulo-nimbus clouds is also illustrated in the p.p.i. picture of Fig. 6. The two-way attenuation at a 10-cm wavelength³ and that at a 25-cm wavelength is shown in Table I for two different rainfall rates.

Fig. 3 shows that for an aircraft low on the horizon the maximum depth of continuous rain which has to be penetrated by the radar is about 150 miles; simple calculation then shows that the attenuation would be 1.6 dB for 10 cm and 0.25 dB in the case of 25 cm. Such orders of attenuation are negligible, resulting in a loss of detection range of under 10%.

In the case of penetrating cumulo-nimbus storm cores the maximum diameter for a single core is not likely to exceed some 5 miles and calculation then shows that the attenuation for a single core would be about 0.13 dB for 10 cm and 0.02 dB

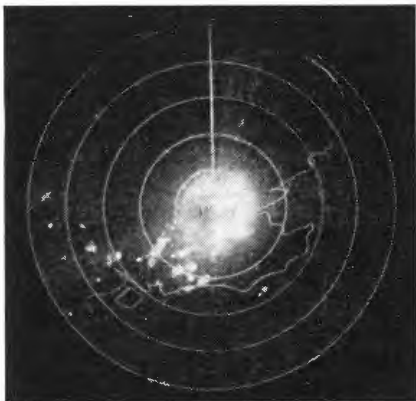

Fig. 6. Isolated cumulo-nimbus storm centres as shown on typical p.p.i. display.

for 25 cm. Again, such orders of attenuation are negligible and even in the unlikely event of some four or five storm centres lying directly between the radar and the wanted aircraft an attenuation of less than 1 dB would be realized at 10 cm with a loss in detection range of only some 5%. It can thus confidently be said that attenuation is no problem to the designer of either 10- or 25-cm radar. The back scatter energy, however, presents a much more formidable problem.

The ratio of the unwanted rain-clutter amplitude to the wanted target amplitude is a function of several parameters⁴. For the basic case of a fan or pencil beam, with the target in its centre and the beam filled by the rain, the ratio may be shown to be:—

$$\frac{S_t}{S_{cr}} = \frac{2A\sigma}{R^2\lambda^2\tau\Sigma\sigma_{cr}}$$

where

S_{cr} = rain clutter echo power
 $\Sigma\sigma_{cr}$ = rain radar cross section per unit volume.

At first sight it would appear from this formula

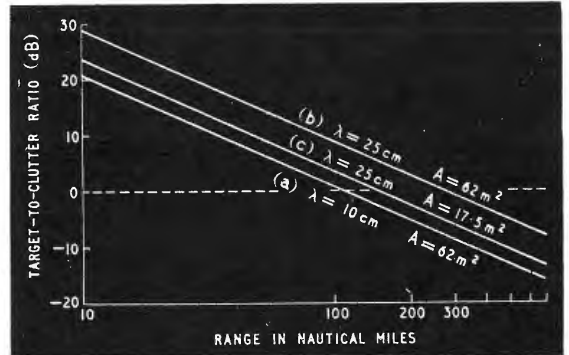

Fig. 7. Theoretical comparison of target-to-rain clutter ratio at 10 and 25 cms for large transport aircraft.

that the target-to-clutter ratio improves as the wavelength decreases. In fact for a given rainfall the effective radar cross section $\Sigma\sigma_{cr}$ increases sharply at shorter wavelengths and is proportional to $1/\lambda^4$. In the case of radars operating at wavelengths of the order of 10 and 25 cm and using established relations for radar cross section, wavelength and rainfall rate³ this formula may be re-stated approximately as:—

$$\frac{S_t}{S_{cr}} = \frac{A\lambda^2\sigma}{FR^2\tau r^{1.23}}$$

where

F = an empirical constant
 r = rainfall rate.

It should be noted from the above that any improvement in discrimination brought about by increase of aerial size or decrease in pulse length results in a directly proportional improvement in target-to-clutter ratio.

Fig. 7 shows a theoretical comparison for 10 and 25 cm of the ratio of echo power from a Viscount aircraft to that from rain of 10 mm/hr, assuming that the aircraft is in the centre of the beam and that the beam is filled by the rain; for simplicity a fan beam has been assumed. Curves (a) and (b) show the performance for the 10- and 25-cm equipments having the same size aerials. However, many 25-cm equipments at present in production

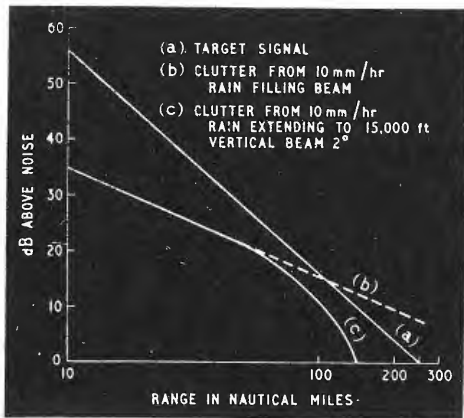

Fig. 8. Practical target and rain clutter amplitudes at 10 cm with large transport aircraft.

use aeriels smaller than 20 square metres and curve (c) shows the performance for a 25-cm radar having the smaller aerial.

The target-to-clutter ratio for the 10-cm radar is 3 dB worse than that of the 25-cm radar with the smaller aerial and 8 dB worse than that with the larger aerial. Of more direct importance is the inference that the the Viscount aircraft would be lost in the clutter at 110 miles on the 10-cm radar and would be held out to 140 miles with a 25-cm radar and smaller aerial or 270 miles with the larger aerial. However, it should be emphasized again that these curves are based on the assumption that the beam is completely filled by the rain at all ranges; this cannot occur in practice with a long-range radar, as may be seen from Fig. 3.

Fig. 8 shows how the story is modified by practical conditions and the case of a 10-cm, high-discrimination radar is now taken, again for simplicity, assuming a fan beam. Curve (a) shows the strength of echo to be expected at various ranges for a Viscount aircraft in the centre of the beam, curve (b) shows the strength of clutter to be expected from 10-mm/hr rainfall filling the beam, curve (c) shows how the intensity of this clutter decreases below the theoretical value at longer ranges until the top of the rain layer falls below the horizon at a range of about

150 miles. It will now be seen that the echo strength of a Viscount aircraft on such an equipment remains greater than the echo strength or 10-mm/hr rainfall at all ranges.

On this basis, it may be said that with the type of fan-beam radar discussed above, the only time when clutter strength is likely to exceed that from a transport aircraft is in the case of the heavy rainfall cores of cumulo-nimbus clouds; such cores occupy only isolated positions on the radar display and it will, in any event, be usual to keep aircraft away from these cores in order to avoid the severe turbulence to which the aircraft would otherwise be subjected. It may thus be seen that with a high-discrimination radar operating on 10 cm the problem of back scatter is by no means so severe as might at first sight have been imagined.

At this stage some attention must be given to the use of cosecant aerial patterns. For the case of an aircraft flying down the main beam, the above arguments continue to apply. For an aircraft which is flying at high altitude at close range and thus in the cosecanted part of the beam, its echo will be relatively weaker than that from rain in the main part of the beam at the same range. Thus, a worsening of the target-to-clutter ratio must be expected, the amount depending upon the characteristics of the cosecanting and the relative altitudes of the aircraft and the rain. This degradation of the ratio may be considerable at high altitude and close range, and if the maintenance of cover at close range is a vital operational requirement, may present a serious problem. It should be remembered, however, that the cosecant technique is not the only way of obtaining high-angle cover and some of the alternative methods avoid or reduce this difficulty. Where the problem remains severe, recent advances in the means of reducing the effect of back-scatter clutter energy are of great value. If a radar transmits circularly polarized radiation, the echoes returned from the spherical rain drops are substantially circularly polarized, but have the characteristic that the direction of the polarization is reversed; such echoes are virtually rejected by the circular polarizing element in the receiver aerial system.^{1,4} On the other hand, the echoes returned from aircraft are substantially linearly polarized and their echoes are accepted by the receiver aerial system. By this means

a big improvement in wanted target-to-clutter ratio can be obtained. In the latest type of radar variable polarization is employed so that adjustment may be made from time to time to secure the maximum rejection under particular clutter conditions. Improvement ratios in the region of 15 to 25 dB have been obtained under practical conditions with this system. Figs. 9 and 10 show the improvement which has been obtained with variable polarization; the results were in fact obtained with a 3-cm radar where rain clutter presents more severe

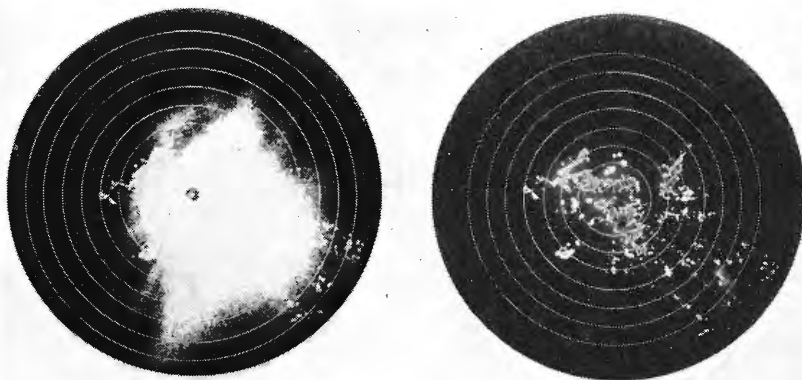

Left: Fig. 9. Effect on p.p.i. display of rain-storm, with horizontal polarization. Right: Fig. 10. Same rain-storm as in Fig. 9 but with circular polarization. Aircraft responses could easily be seen through the small residue of clutter.

problems than at 10 cm.

While circular polarization brings about a substantial improvement in target-to-clutter ratio, the technique of using a logarithmic amplifier has quite another purpose. To appreciate the purpose of logarithmic amplifiers for clutter reduction, it must be remembered that on a p.p.i. display, quite weak clutter echoes can saturate the display and hence mask very much stronger target echoes. It is here that the logarithmic amplifier technique in the radar receiver is of great value. The use of a logarithmic amplifier

followed by a differentiating circuit may be shown mathematically⁶ to have the property of reducing the strength of all randomly fluctuating signals to a common level. The echo intensity from rainfall fluctuates approximately in this manner, as does the receiver noise; consequently when rain-clutter echoes are passed through a logarithmic amplifier and differentiating network, they appear at the output to have the same level as the receiver noise. On the display, the rain-clutter echoes will therefore be indistinguishable (or scarcely distinguishable) from the background noise, thus clearing the clutter from the display and allowing the stronger target echoes to be seen. In practice very strong clutter echoes are reduced substantially to noise level; this is illustrated in Figs. 11 and 12, which were again taken with a 3-cm radar.

Summary.—A 10-cm radar having the same bulk of equipment as a 25-cm one can offer a 58% greater range of detection in clear weather. Such equipment offers a 2½-times improvement in discrimination and a continuity of cover which is difficult to obtain at longer wavelengths. On the subject of ground clutter there is little to choose between the two wavelengths.

Attenuation in rain is no problem for either a 10-cm or a 25-cm equipment. The back-scatter clutter from rain presents greater problems on 10 cm than 25 cm; however, the problems at 10 cm

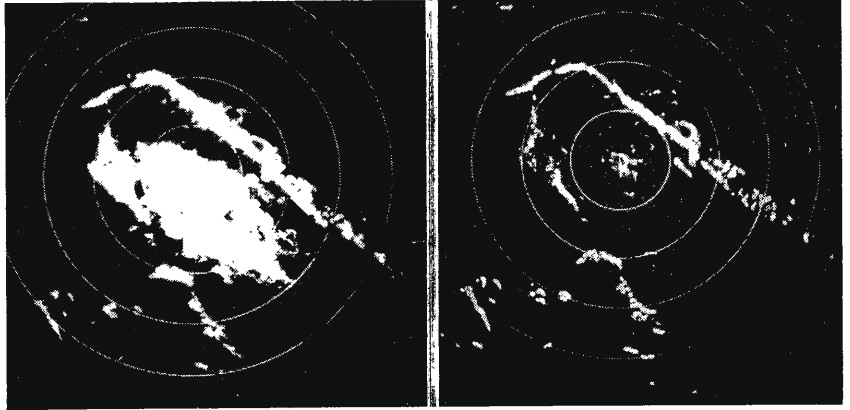

Left: Fig. 11. Effect of rain storm using linear amplification in receiver. Right: Fig. 12. Same rain storm as in Fig. 11 but using logarithmic amplification and differentiation in the receiver. Ground clutter is still present, but reduced in intensity.

are, for the most part, not too serious with a high-discrimination radar and great strides have been made in anti-clutter techniques.

This investigation has not given an unequivocal answer to the question of which is the better operating wavelength; indeed in the authors' opinion there is no direct general answer. A particular 10-cm radar may be either better or worse than a particular 25-cm one in almost any of the respects examined above. It is the authors' opinion that no choice should ever be based on a general preference for either wavelength; a particular choice should be based on a thorough study of the parameters of the individual radars available and this should be examined in relation to the operational requirements.

REFERENCES

- ¹Ridenour, L. N. *Radar System Engineering*. McGraw Hill.
- ²Ryde, J. W. "Attenuation and Radar Echoes at Centimetre Wavelengths" *Meteorological Factors in Radio Wave Propagation*. Physical Society, London.
- ³Gunn, K. L. S. and East, T. W. R. "Microwave Properties of Precipitation Particles." *Q.J.R. Meteorological Society*, London, 1954.
- ⁴Ramsay, J. F. "Proceedings of a Conference on Centimetric Aerials for Marine Radar." H.M.S.O., London.
- ⁵Croncy, J. "The Reduction of Sea and Rain Clutter in Marine Radar." *J. Inst. Nav.*, Vol. 7, No. 2. John Murray, London.

U.K. GEOPHYSICAL YEAR

MUCH valuable information has been compiled on the constitution of the radio reflecting layers by probing the ionosphere with radio signals transmitted from the ground. During the present year it is hoped to add considerably to this knowledge by sending aloft in rockets radio transmitters and receivers. Plans have been made, as part of the United Kingdom contribution to the International Geophysical Year (July, 1957, to December, 1958), to commence these investigations shortly at the Woomera rocket range in Australia, where preparations have been in hand since mid-February.

It is the object of the experiments, which are under the direction of the Royal Society, to determine, with greater exactitude than has been possible hitherto, the degree of ionization and also the actual types if ion

or atom present in the ionosphere. Ions will be collected by suitable equipment in the rocket, which will be able to determine their mass, nature of their electrical charge and any other relevant details, and transmit the acquired information to the ground by radio as the rocket ascends through the E and F layers. Some of these experiments are framed to provide precise data on the variation of free electron concentration in the troposphere and ionosphere with height.

The greater part of this work is being undertaken by the physics and electrical engineering departments of the University of Birmingham, University Colleges of London and Swansea, and the Royal Air Force. Assistance is afforded by the Royal Naval Scientific Service in the provision of special equipment.

Transistor Graphical Symbols

A Critical Analysis of Existing Ideas and Conventions

By "CATHODE RAY"

WHEN last discussing transistors (Dec., 1956, issue) I thought I was probably sticking my neck out recklessly for in urging all concerned to abolish the ticks, dashes, primes, or whatever you call them, that distinguish common-emitter parameters from common-base. I thought—and still think—it quite fantastic that everyone should be condemned for the rest of time to keep on writing α' , r_0 , h'_{12} , etc. (and putting the dashes in again whenever the typist or compositor misses them out), while reserving α , r_c , h_{12} , etc., for the small and diminishing number of occasions when the common-base configuration is intended. The sooner this false start is corrected the better. But from past form I expected the people who had been using the unticked symbols for several years for common-base conditions would object strongly to the idea of changing them over to mean something different, no matter what could be said in favour. So I cautiously interpreted the total absence of correspondence on this subject as silent contempt.

Imagine, then, my pleasurable surprise when, at a well-attended gathering of transistor educationalists, the suggestion was not only endorsed by several authorities but well received by the rest, with no audible opposition. I shall be even more pleased and surprised if, in a year or two, it will be safe to interpret references to " α " as meaning current amplification factor in common-emitter, except where the contrary is specified, or in antiquarian contexts relating to point-contact transistors.*

Having already developed at some length the arguments for dropping the decorations from α , etc., I will not repeat them here but will go on to the question of graphical symbols for transistors. Fig. 1 shows some of those that have been suggested. There are probably others.

What do we say? Well, one thing that sticks out clearly from all the diversity of ideas is (with due respect to Mr. Thompson) that the symbol originally invented for the point-contact transistor is a good one—for the point-contact transistor. It fulfils all

the requirements for a circuit symbol: it strongly suggests the thing it represents; it is easy to draw; it fits in easily to circuit diagrams; and it has become generally accepted. So, say I, as Glasgow says about itself, let it flourish.

So good is it that it has become generally used, though less enthusiastically, to represent junction transistors too. The lack of enthusiasm is demonstrated by the number of alternatives that have been proposed. Yet nearly everybody keeps on using it. And it is the only kind shown in the recent Supplement No. 4 to B.S. 530 ("Graphical Symbols for Telecommunications"). Why shouldn't it be?

* Since the above was written a letter has appeared, from M. O. Felix, of Canada, advising me to adopt β as the substitute for α' . With all respect I disagree, for β (or B) in amplifier contexts is well understood to mean feedback ratio, and to use it also to mean an amplification factor is to make confusion worse confounded.

Fig. 1. Some of the many proposed transistor symbols. (The blobs on the envelopes normally used by Wireless World have been deliberately omitted).

PROPOSER	REFERENCE	POINT CONTACT		JUNCTION	
		p-n-p	n-p-n	p-n-p	n-p-n
HENRY MORGAN	WIRELESS WORLD APRIL 1954 p.178				
P.M. THOMPSON	WIRELESS WORLD JULY 1954 p.325				
E. AISBERG	WIRELESS WORLD MARCH 1955 p.125				
G.B.B. CHAPLIN	PROC. I.E.E. (B) NOVEMBER 1955 p.788				
H.J. COOKE	WIRELESS WORLD DECEMBER 1956 p.600				

There are at least two reasons, so strong that in my humble opinion they demand action.

The first is that it doesn't in the least suggest a junction transistor. If the Editor will pardon my saying so, this applies especially to the *Wireless World* version, in which a great thick slab, like a foundation stone, is used to represent the thinnest possible layer of solid that modern technique can contrive. An even more obvious discrepancy is that the two other electrodes of a junction transistor are *not* on the same side of the base, and they are *not* points.

The other reason is that the conventional symbol, when used for a junction transistor, strongly suggests something that it *isn't*. It completely fails to make an important distinction. So, looking at a transistor circuit diagram, one wastes time searching for information on which kind of transistor is meant. If point-contacts become completely obsolete that objection will disappear, but we will still be left with an absurdly inappropriate symbol.

Again, the sooner the false start is corrected the easier it will be.

What about the alternatives in Fig. 1?

To qualify for consideration, any suggested symbol should be (1) suggestive of a *junction* transistor, (2) easy to draw quickly on paper or blackboard, and (3) easy to distinguish from all other symbols. For judging between otherwise equally good entrants, one might also have to take into account (4) adaptability to circuit diagrams, (5) adaptability to future developments in transistors—more electrodes, for example—and (6) some measure of existing use.

Under requirement (2) I would immediately rule out all symbols with areas that have to be blacked (or whited) in. Life these days is just too short. It is bad enough having to do it for non-thermionic rectifiers, but (looking forward) at least those occur less often than transistors. The difference between p-n-p and n-p-n can much more easily be shown by an arrowhead as heretofore. That disposes at once of all the suggestions in Fig. 1 except for those by E. Aisberg. While it grieves me to criticize adversely such a good friend's proposal, I cannot avoid pointing out that it perpetuates the error of showing emitter and collector on the same side of the base. So all go.

Textbook Symbol

If I were to put forward a brand-new suggestion of my own it could be shot down under requirement (6), at least. Fortunately that is not necessary. There is a symbol which is used throughout one of the transistor world's most popular textbooks—"Transistor Electronics," by Messrs. Lo, Endres, Zawels, Waldhauer and Cheng, all of the Radio Corporation of America. To descend from the sublime to the ridiculous, it has also been used privately for some time with great satisfaction by "Cathode Ray," who is determined to continue using it until something better can be shown. Regular readers will testify that I am not unduly biased in favour of American practice, even when advocated by authors of such widespread ancestry as the above names suggest. The basis for my enthusiasm is that their symbol, shown here as Fig 2, adequately fulfils all the other five requirements too.

(1) Though it could be argued that some of the

alternatives in Fig. 1 more closely resemble a junction transistor—the gap between collector and base in Fig. 2 could be criticized, for example—there can be little doubt about the superiority of Fig. 2 over the point-contact type of symbol; in particular, the essential thinness of the base is emphasized. Accepted practice rightly favours circuit symbols that primarily suggest function, with only a very general hint of outward appearance—liable to change in detail.

(2) Both for quick sketching and formal drawing, Fig. 2 has a marked advantage over any of the symbols shown in Fig. 1.

(3) There can be no doubt that the important distinction between point-contact and junction transistors is duly made. At the same time it clearly points the analogy between the junction transistor and the valve. In fact, the only criticism I can

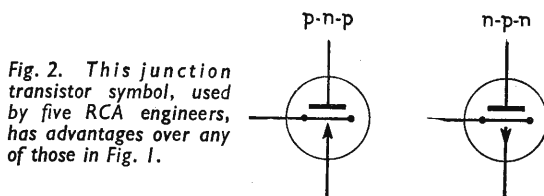

Fig. 2. This junction transistor symbol, used by five RCA engineers, has advantages over any of those in Fig. 1.

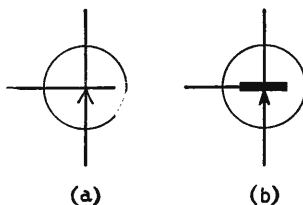

Fig. 3. (a) is a recent suggestion, by James Franklin; it can be regarded as a simplified form of Fig. 2. The corresponding n-p-n symbol would presumably have the arrow pointing downwards. At (b) is a similar version used by W. T. Bane and D. L. A. Berber.

imagine as having any weight (though it has none with me) is that this analogy is pointed *too* clearly. There is, I believe, a school of thought that deprecates likening a transistor to a valve. Personally I hold that transistors have so much in common with valves, as regards function, methods of use, and to some extent internal workings, that it is futile *not* to note the similarities. I haven't found in practice that there is any danger whatsoever of actually confusing the Fig. 2 symbol with that for a valve. Use of the point-contact symbol for junction transistors, however, certainly is confusing to learners.

(4) and (5) Just as the original valve symbol has proved itself adaptable to all the many elaborations that 50 years of history have forced upon it, so Fig. 2 should be equal to all eventualities, and be no less at home in circuit diagrams.

Another suggestion since the above was written is that by James Franklin, Fig. 3 (a), with a slightly more elaborate version from the *Journal of Scientific Instruments* at (b). This is even quicker to draw than Fig. 2, and escapes the criticism about the collector gap and also any objection on the ground of too closely resembling a valve. I regard it as a simplified and preferred version of Fig. 2 and wholeheartedly support it.

While on this subject, we might give some attention to the old question: To envelope or not to envelope? There are a few authorities on both sides

of the Atlantic who draw valve symbols all naked. No doubt they argue that the bottle is just an external covering, and mere external coverings are not shown in circuit diagrams unless they have some electrical function, such as screening. On the other side it can be argued that no valve would function electrically or in any other way without its envelope. This argument loses some of its force with a transistor, because it could work without, though probably not very long in our climate, and not very well, because it is affected by light. So it is rather commoner to omit the container from transistor symbols. But to my mind the real reason for drawing it round valve electrodes is to make the valves—which are key components—stand out clearly in the diagram. The test is: Are circuit diagrams in which the valves are represented only by their electrodes more difficult to read? To me they certainly are. This line of argument applies a shade less to conventional transistor symbols, in which all the electrodes are in contact; but even so they are not entirely easy to distinguish from mere circuit connections, and I am sure the envelope is helpful.

But please, Mr. Editor, may I appeal for the omission of the blobs where the leads pass through the envelope? Everywhere else these blobs mean electrical connection, so when used in valve and transistor symbols they indicate that all the electrodes are shorted to one another!

Drawing Supply Lines

Another point of practice in transistor circuit diagrams has been debated a good deal lately, so I think it ought to be mentioned here, even though this time I agree so much with both sides that I haven't been able to come down permanently on either. It has for long in Britain (though less so in America) been standard practice to draw circuit diagrams with a thick horizontal line to represent wiring at earth potential and to place positive parts above it and negative below. In this way the diagram not only shows how the components are connected up but by indicating the relative potentials it helps one to see how the whole thing works.

But when we come, full of helpfulness, to draw transistor circuits, what do we do? If we follow the same plan we have to draw the diagram apparently upside down, with "earth" at the top and "h.t." at the bottom; for the only transistors readily obtain-

able here just now are p-n-p types, which need negative supplies. This arrangement is rather disconcerting to those who have become used to the other way. On the other hand, if we draw the diagram the "right" way up, so that it is easily recognizable, we break the ancient and honourable custom of making potential increase positively upwards, and thereby introduce difficulties of another sort.

To the conscientious it is an agonizing choice. It almost—but not quite—drives me into the camp of those who scrupulously avoid any hint of a suggestion that transistors have anything in common with valves, for it gives them one of the very few real opportunities to justify this viewpoint, by making transistor circuits look as unlike valve circuits as possible. To those of us who find the resemblances too striking to be ignored, it is hard to adhere to a principle that deprives us of the opportunity of showing beginners how easy transistors are—by substituting transistor symbols (preferably of the Fig. 2 variety!) for the valves in almost any amplifier circuit, and adding bias resistors from "h.t." to bases. Yet admittedly this easy-at-first way does make difficulties in detailed analysis of circuit action, especially in circuits of the less usual kinds, such as those including both p-n-p transistors and valves, or both kinds of transistors. Of course, if n-p-n became the rule rather than the exception, this dilemma would disappear. In the meantime, my way out (as you may have noticed last September) is to introduce transistors via valves by assuming the n-p-n variety, and then casually mentioning that the only sort you can actually buy is the p-n-p, which is the same except for all the polarities being reversed—a difference too trifling, of course, in these days of the nation's critical financial position to justify the expense of a new diagram solely to show it. And then one passes hurriedly on to something else. But sooner or later one has to draw a practical circuit, and then. . . ! Some authorities postpone the issue by continuing to draw diagrams which apparently are conventional, unless one notices "-h.t." at the top right-hand corner where "+h.t." was wont to be. But Nemesis overtakes even them in time, for evil spirits lure them into writing an I.E.E. paper, which naturally has to include circuits sufficiently tricky to justify acceptance; and then they come in for a lot of pointed criticism from the floor for failing to adhere to standard practice based on common sense.

This is not all, for precisely the same dilemma awaits us when we draw characteristic curves. Ought we to show them as at Fig. 4 (a) or (b)? I suppose I ought to condemn (a) with ruthless scorn, but cannot yet bring myself to be strictly logical in this matter, any more than with the circuit diagrams. I rather hope (b) will come in time, though.

Readers of past ruthless scorns may wonder that I should have conceded so much as to write "h.t." even in inverted commas, when the description "high tension" is even more absurd applied to transistor batteries than it is low-power valve circuits. Yes, it does seem to me a misuse of language, to put it mildly; but in thinking so I am probably in a minority of one.

A more important matter arises when one begins to study the transistor in earnest. This is the stage where one treats it as a box of mystery (Fig. 5)

(Continued on page 197)

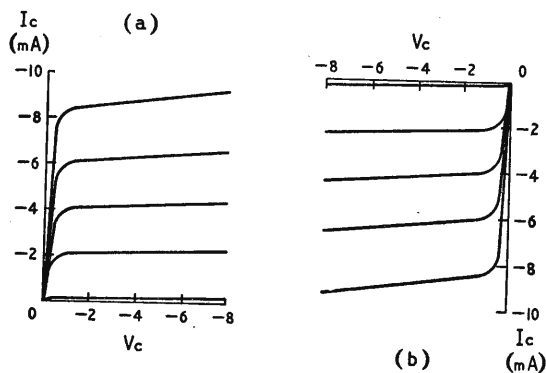

Fig. 4. (b) is undoubtedly the correct way of drawing p-n-p characteristics, but most people still use (a).

investigated exclusively by measuring the input and output currents and voltages. To do this without getting into a muddle with plus and minus signs, one has to decide beforehand which directions to call positive. If everybody decides the same way, the advantages are obvious. Faced with Fig. 5, what would you do, chum?

I imagine that nobody would seriously question a decision to reckon the positive direction of input current as *into* terminal 1. Nor, I guess, would riots break out on the announcement that the positive polarities of input and output voltages are those of terminals 1 and 3 respectively with reference to the common or earth terminals 2 and 4. It is the direction of output current that causes the trouble.

Being a simple sort of bloke, I tend to think of "output current" as the current that comes out. No doubt that is a shockingly unreasonable thing to do, in view of those pundits who have ruled that the positive direction of outward current is *into* the output terminal. So far I have not been able to trace any reasons for this ruling. On the contrary, nearly all the authorities on passive and non-transistor active four-terminal circuits show the output current coming out. Perhaps one or two of the transistor pundits would write and tell me why they reverse the accepted convention. Perhaps they will suppose it had not occurred to me that the right answers can be obtained by following either convention, so that the choice is purely arbitrary and therefore not open to question on grounds of rightness or wrongness. But unless some overriding consideration comes in, it does seem kinder to decide on what is likely to come most natural to the tender student. In my simplicity I would be inclined to suppose that terminal 3 being positive (relative to 4) would tend to imply a positive current coming *from* 3 into 4.

I can see, of course, that if one is so naive as to forget that the box contains an equivalent circuit, with magic generators and things, and not a transistor or valve, there arises the old controversy about which way the signal current flows in a valve anode circuit. This is further complicated by the newer controversy as to whether a transistor is or is not something like a valve. One can get caught both ways. A long time ago* I proved to my own satisfaction, with a generous output of ruthless scorn, that according to the established custom of reckoning the anode potential with respect to the cathode, and not the other way about, there is no escape from the conclusion that the logical positive direction of signal current is *out* from the terminal of the equivalent circuit that represents the anode. That is to say, it is opposite to the feed current, which is irrelevant in an equivalent circuit. This conclusion, of course, was far from original, for it agreed with many reputable authorities. And none of the others has contested the argument.

If one holds that a transistor *is* something like a valve, then logically *its* equivalent circuit in the common-emitter configuration should have its positive output current coming *out* from terminal 3. Those who are with me on the first point, but who delight in every chance to emphasize the differences between transistors and valves, will no doubt seize this one, and thereby align themselves with the pundits. On the other hand, some of those who

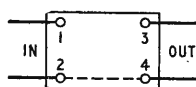
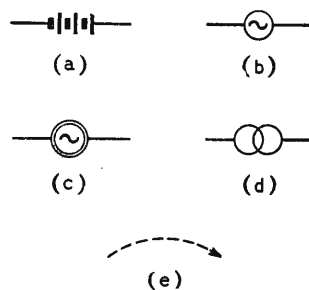

Fig. 5. In this "black box" representation of a transistor, which do you regard as the positive direction of output current?

Fig. 6. The direct (a) and alternating (b) voltage generator symbols have no generally accepted current counterparts, though (c), (d) and (e) have been used.



admit the transistor-valve analogy may perhaps insist on valve signal current going the same way as its breakfast. But I can't believe there are no others, especially since the educationalists, who showed their enlightenment by endorsing my views on what the Duke of Wellington would have called "those d—dashes," further demonstrated their quality by strongly deprecating the inward output current convention. If they carry these opinions into the classrooms and lecture theatres there is hope for the future generation.

The coming of transistor equipment circuits has greatly increased the frequency of occasions when it is necessary to indicate a current generator, and thereby has accentuated the unsatisfactory symbol position. A theoretical voltage generator is something that provides an e.m.f. in series with a current path without adding any impedance. Practical voltage generators such as batteries and a.c. machines can approximate quite closely to this specification, so their recognized symbols, Fig. 6 (a) and (b), are appropriate. A theoretical current generator is something that transfers current from one point to another without adding an admittance. Such a thing does not exist in real life, so perhaps it is hardly surprising that there is difficulty about a symbol.

The best practical approximation is a very high voltage generator in series with a very high resistance, but this would be confusing if shown in standard symbols. Recently I consented, under protest, to symbol (c) being used for my diagrams. It doesn't seem to me to be an obvious current counterpart to (a) or (b), and it certainly doesn't suggest an open circuit. Alternative (d) is no better except for being more widely used, and has the disadvantage of being the same as an international symbol for a transformer. The British Standards Institution has no symbol for any kind of signal generator—not even (b)—an astonishing fact to which I would draw the attention of the appropriate B.S.I. committee.

Some time ago (April, 1952, issue) I made use of an American idea—a curved dotted arrow (e), which at least suggests an open circuit and shows the positive direction, but does not always specify the terminal points closely. Moreover it is not particularly suggestive of a generator, and unless anyone can do better I would like to propose the already well-established theoretical alternating signal

* *Wireless World*, September 1946. (Chapter 30 in *Second Thoughts on Radio Theory*.)

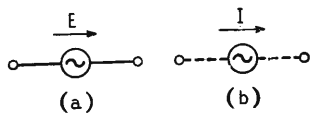

Fig. 7. (b) would seem to be the natural counterpart to (a); the dotted line implies the required open circuit.

Fig. 7 (b). This symbolism would give logical expression to what the two things have in common and to what distinguishes them.

P.S.—I have just seen that in the new book "Vacuum-Tube Circuits and Transistors," by Arguimbau and Adler, they denote a current generator by the symbol Fig. 8. I see no justification for replacing the well-known a.c. generator device of a sine wave by a straight arrow, which suggests something different, but I do welcome support of the dotted line idea from a source for which I have great respect.

Fig. 8. The dotted line appears in this current-generator symbol by Arguimbau and Adler.



generator symbol—Fig. 6 (b)—for both voltage and current, the absence of conducting path in the current case being indicated by dotted leads, as in

COMPONENTS SHOW EXHIBITORS

A RECORD number of exhibitors (listed below) are participating in the annual Components Exhibition (April 8th to 11th) at Grosvenor House and Park Lane House, London, W.1.

Free admission tickets are obtainable from the Radio

and Electronic Component Manufacturers' Federation, 21, Tothill Street, London, S.W.1, by engineers and technicians in the "user" industries, research and the Services. The Show opens daily at 10.0, closing at 6.0 on the first three days and 5.0 on the last day.

A.B. Metal Products
A.K. Fans
Advance Components
Aero Research
Air Control Installations
Allan Radio
Anglo-American Vulcanized Fibre
Antiference
Ashdowns
Avo

Bakelite
Belling and Lee
Bird, Sydney S., & Sons
Bray, Geo., & Co.
Brayhead (Ascot)
Brimar
British Communications & Electronics
British Electric Resistance
B.I. Callender's Cables
British Moulded Plastics
British Physical Laboratories
Bulgin
Bullers

Carr Fastener
Cathodeon Crystals
Clarke and Co. (Manchester)
Collaro
Colvern
Connollys (Blackley)
Cosmocord
Creators

D.S.I.R.
Daly (Condensers)
Darwins
Dawe Instruments
De La Rue
Diamond H Switches
Dubilier
Duratube and Wire

Eddystone
Edison Swan
Egen Electric
Electro Acoustic Industries
Electro Methods
Electronic Components
Electronic Engineering
Electrothermal Engineering
Enalon Plastics
English Electric
Enthoven Solders
Erg Industrial Corp.
Eric Resistor
Ever Ready

Ferranti
Film Industries

Fine Wires
Fortiphone

G.E.C.
Garrard
Goldring
Goodmans
Gresham Transformers
Guest Keen and Nettlefolds

Haddon Transformers
Hallam, Sleigh and Cheston
Harwin Engineers
Hassett and Harper
Hellermann
Henley's
Hunt (Capacitors)

Imhof
Insulating Components and Materials

Jackson Bros.
J. Beam Aerials

K.L.G. Sparking Plugs

Langley London
Linton and Hirst
Lion Electronic Developments
London Electrical Mfg. Co.
London Electric Wire Co.
Long and Hambly
Lustraphone

Magnetic and Electrical Alloys
Magnetic Devices
Mallory Batteries
Marrison and Catherall
McMurdo Instrument Co.
Measuring Instruments (Pullin)
Mica and Micanite Supplies
Micanite and Insulators Co.
Minnesota Mining and Mfg. Co.
Morganite Resistors
Mullard
Mullard Overseas
Multicore Solders
Murex
Mycalex and T.I.M.

N.S.F.
Neill, James, and Co.

Painton
Parmeko
Partridge Transformers
Permanoid
Plannair
Plessey Co.
Plessey International
Power Controls

Radio Instruments
Reliance Electrical Wire Co.
Reproducers and Amplifiers
Rola Celestion

Salford Electrical Instruments
Salter, Geo., and Co.
Scott, Geo. L., and Co.
Shell Chemical Co.
Simmonds Aerocessories
Simon Equipment
Sims, F. D.
Spear Engineering Co.
Stability Capacitors
Standard Insulator Co.
Standard Telephones and Cables
Static Condenser Co.
Steatite and Porcelain Products
Stocko (Metal Works)
Suflex
Supply, Ministry of
Swift Levick and Sons
Symons, H. D., and Co.

Taylor Electrical Instruments
Technical Ceramics
Telcon Magnetic Cores
Telegraph Condenser Co.
Telegraph Construction & Maintenance
Telephone Manufacturing Co.
Thermo-Plastics
Thorn Electrical Industries
Truvox
Tucker, Geo., Eyelet Co.
Tufnol

Vactite Wire Co.
Vitavox

Walter Instruments
Wandeside Cable Works
Waveforms
Wego Condenser Co.
Welwyn Electrical Laboratories
Westinghouse
Weymouth Radio Manufacturing Co.
Whiteley Electrical
Wiggin, Henry, and Co.
Wimbledon Engineering Co.
Wingrove and Rogers
Wireless Telephone Co.
Wireless World and Electronic & Radio Engineer
Woden Transformer Co.
Wolsey Television
Wright and Weaire

Zenith Electric Co.

APRIL MEETINGS

LONDON

1st. I.E.E.—“Colour television” talks by L. C. Jesty and Dr. E. L. C. White at 5.30 at Savoy Place, W.C.2.

4th. I.E.E.—The forty-eighth Kelvin Lecture on “Infra-red radiation” by Dr. G.B.B.M. Sutherland at 5.30 at Savoy Place, W.C.2.

4th. London U.H.F. Group.—“Crystal control circuits” by a representative of Cathodeon, Ltd., at 7.30 at the Bedford Corner Hotel, Bayley Street, W.C.1.

5th. Royal Institution.—“The first transatlantic telephone cable” by Sir Gordon Radley at 9.0 at 21 Albemarle Street, W.1.

10th. I.E.E.—“The remote and automatic control of semi-attended broadcasting transmitters” by R. T. B. Wynn and F. A. Peachey at 5.30 at Savoy Place, W.C.2.

10th. Radar Association.—“Radar techniques and research on wave propagation” by Dr. R. L. Smith-Rose at 7.30 at the Anatomy Theatre, University College, Gower Street, W.C.1.

12th. B.S.R.A.—“Properties and performance of magnetic tape” by Dr. G. F. Dutton at 7.15 at the Royal Society of Arts, John Adam Street, Adelphi, W.C.2.

17th. British Kinematograph Society.—“A new approach to telerecording” by A. E. Sarson and P. B. Stock, with an introductory survey by L. C. Jesty at 7.15 at the Royal Society of Arts, John Adam Street, Adelphi, W.C.2.

24th. Brit.I.R.E.—“The properties of semi-conductor devices” by Dr. A. A. Shepherd at 6.30 at the London School of Hygiene and Tropical Medicine, Keppel Street, W.C.1.

26th. Institute of Navigation.—“Methods of obtaining a ship's aspect and speed by radar” by Captain R. G. Swallow and A. L. P. Milwright at 5.15 at the Royal Geographical Society, 1 Kensington Gore, S.W.7.

29th. I.E.E.—“Radio in air-sea rescue” talks by G. W. Hosie, D. Kerr and W. Kiryluk at 5.30 at Savoy Place, W.C.2.

30th. Plastics Institute.—“Thermoplastics in the submarine-cable industry” by Sir John Dean at 6.30 at the I.E.E., Savoy Place, W.C.2.

CHELTENHAM

5th. Brit.I.R.E.—“Colour television” by Dr. G. N. Patchett at 7.0 at the North Gloucestershire Technical College.

EDINBURGH

16th. I.E.E.—“An introduction to some technical factors affecting point-to-point communication systems” by F. J. M. Laver at 7.0 at the Carlton Hotel, North Bridge.

26th. Brit.I.R.E.—“Special process instrumentation in atomic energy projects” by H. Bisby at 7.0 at the Department of Natural Philosophy, University of Edinburgh.

GLASGOW

4th. Brit.I.R.E.—“Telemetry” by A. Cowie at 7.0 at the Institution of Engineers and Shipbuilders, 39 Elm-bank Crescent.

LIVERPOOL

11th. Brit.I.R.E.—“Electronics in aircraft installations” by F. Ellson-Jones and “A negative feedback circuit for magnetic c.r.t. deflection” by S. L. Fife at 6.45 at the Chamber of Commerce, 1 Old Hall Street.

MALVERN

8th. I.E.E.—“Stereosonic sound” by H. A. M. Clarke at 6.0 at the Winter Gardens.

MANCHESTER

4th. Brit.I.R.E.—“Electronic control of machine tools” by H. Ogden at 6.30 at the Reynolds Hall, College of Technology, Sackville Street.

NEWCASTLE-ON-TYNE

1st. I.E.E.—“The B.B.C. sound broadcasting service on very-high frequencies” by E. W. Hayes and H. Page at 6.0 at King's College.

SHEFFIELD

17th. I.E.E.—“The B.B.C. sound broadcasting service on very-high frequencies” by E. W. Hayes and H. Page at 6.30 at the Grand Hotel.

STONE

15th. I.E.E.—“Electronics and automation: some industrial applications” by Dr. H. A. Thomas at 7.0 at the Duncan Hall.

TORQUAY

4th. I.E.E.—“Television interference” by P. W. Crouch at 3.0 at the Electric Hall.

LATE MARCH MEETING

London

29th. R.S.G.B.—“Mobile operation.” Discussion opened by F. W. Crabtree (G3BK) and R. G. Shears (G8KW) at 6.30 at the I.E.E., Savoy Place, W.C.2.

CLUB NEWS

Bradford.—A. R. Bailey, B.Sc. (G3IBN) will deal with d.f. equipment when speaking at the meeting of the Bradford Amateur Radio Society on April 9th. The meeting will be held at 7.30 at Cambridge House, 66, Little Horton Lane. On the 30th the club is visiting Yeadon Airport. Sec.: F. J. Davies, 39, Pullan Avenue, Eccleshill, Bradford, 2.

Derby.—The Derby and District Amateur Radio Society, which has a membership of 100, continues to meet each Wednesday at 7.30 at 119, Green Lane. On April 24th N. Birkett (G3EKX) will speak about radar equipments. Sec.: F. C. Ward (G2CVV), 5, Uplands Avenue, Littleover, Derby.

Warrington.—The programme of the bi-monthly meetings of the Warrington and District Amateur Radio Society includes a course on radio fundamentals. The club meets at 7.30 on the first and third Thursdays of each month at the Royal Oak Hotel, Bridge Street. Sec.: J. Mather, 28, Chapel Road, Penketh, Nr. Warrington, Lancs.

Wellingborough.—“Transistor receivers” is the subject to be dealt with at the meeting of the Wellingborough and District Radio and Television Society on April 11th. The club meets every Thursday at 7.30 at Silver Street Club Room. Sec.: P. E. B. Butler, 84, Wellingborough Road, Rushden.



sound equipment serves the world



See and hear
our products at
THE LONDON



APRIL

12 · 13 · 14 · 15

Waldorf Hotel,
London, W.C.2.

THE TRIX ELECTRICAL CO. LTD.
MAPLE PLACE, TOTTENHAM CT. RD.,
LONDON, W.1

Tel.: MUS 5817. Grams.: Trixadio, Wesdo, London

RANDOM RADIATIONS

By "DIALLIST"

Guarantees

REFERRING to my recent protest against the mingy guarantees of valves and c.r. tubes in sound and television receivers, the editor pointed out in the February issue that Ambassador and Baird are now throwing in an extra year's guarantee on the tubes in their sets. This is indeed a step in the right direction and one which will greatly increase goodwill by setting the television receiver owner's mind at rest. And, I imagine, the extra cost to set manufacturers who offer these extended guarantees will be almost negligible. J. W. Ridgeway, chairman of the B.V.A., speaking on the findings of the Monopolies Commission, reminded us that a tube which survives the first few months of its life is likely to go on giving satisfactory service for at least three or four years. Incidentally the report certainly shows who takes the biggest slice of the profit on c.r. tubes—the Government! A break-down of the prices prevailing in 1954 (they have since been reduced) shows that of the £20 10s 1d charged for a 14-inch tube, £5 15s 1d went to the Chancellor of the Exchequer in purchase tax. Of the present-day price of £25 18s for a 21-inch tube, the manufacturer gets £11 4s, distribution costs account for £6 16s and P.T. for £7 18s.

Two-year Comprehensive

I am much obliged to a Radio Rentals branch manager, who writes "with practically every sale we make there is a two-year guarantee. The only exceptions are the very occasional customers who wish to purchase at a slightly lower cost price and forgo this guarantee." The guarantee (of which he sends me a copy) is simple, comprehensive and unambiguous. Besides the valves, c.r. tube and components it covers all service and maintenance charges. The customer doesn't obtain a free replacement of some small part and have to pay, maybe, five or six times its value for having the "dud" taken out and the new one put in. The difference between the "with" and "without" such guarantee prices are surprisingly low. They work out at

£7 17s 6d for each of the two years for a 17-inch table model television receiver and 31s a year for an a.m./f.m. receiver. It seems obvious that a full year's guarantee for valves and tubes, without service and maintenance, could be given by set manufacturers without any substantial increase in prices. Something of the sort will certainly have to come and the sooner it comes, the better for all concerned.

We Like F.M.!

AS I'VE mentioned before, reception in many parts of East Anglia was pretty hopeless when we were served by a.m. transmitters and nothing else. Now that the Norwich f.m. transmitter is radiating on full power people who have gone in for v.h.f. receivers are lost in admiration of the clarity and high quality of their reception, and of the complete freedom from interference they enjoy. Being unable to make the medium-wave and long-wave ranges serve any useful purpose, most of the folk I know have bought or intend to buy f.m.-only sets. There are comparatively few such models on the market, and I'm sure it would pay more manufacturers to offer them. And may I ask any maker who is contemplating the marketing of such a set to con-

sider what a strong selling point press-button tuning for three pre-set frequencies would be?

Geophysical Year

THE coming International Geophysical Year—or rather, year-and-a-half, for it starts on the coming first of July and lasts till the end of next year—should bring results of the greatest value for broadcasting and for telecommunications. The previous concerted researches of this kind, held in 1882-83 and 1932-33, were called international polar years, for they were concerned mainly with the polar aspects of the earth's magnetism. In the coming Geophysical Year observations will not be restricted to the polar regions but will be made and records kept at stations all over the world. From these and from the instruments sent up in artificial satellites and in giant rockets we should come to know a great deal more than we do now, not only about such things as the aurora borealis and magnetic storms, but also about the upper troposphere, the ionosphere and other reflecting layers. I shouldn't be a bit surprised if some of our present accepted ideas about the long-distance propagation of electromagnetic waves in some parts of the radio spectrum have to be consider-



"WIRELESS WORLD" PUBLICATIONS

	Net Price	By Post
TELEVISION ENGINEERING: Principles and Practice. Volume III: Waveform Generation. S. W. Amos, B.Sc. (Hons.), A.M.I.E.E. and D. C. Birkinshaw, M.B.E., M.A., M.I.E.E. ...	30/-	30/11
TELEVISION RECEIVING EQUIPMENT. W. T. Cocking, M.I.E.E. 4th Edition ...	30/-	31/6
FOUNDATIONS OF WIRELESS. M. G. Scroggie, B.Sc., M.I.E.E. 6th Edition ...	12/6	13/6
WIRELESS SERVICING MANUAL. W. T. Cocking, M.I.E.E. 9th Edition ...	17/6	18/6
RADIO VALVE DATA: Characteristics of over 2,500 Valves, Transistors and C.R. Tubes. Compiled by <i>Wireless World</i> ...	5/-	5/7
SECOND THOUGHTS ON RADIO THEORY. "Cathode Ray" of <i>Wireless World</i> ...	25/-	26/2
RADIO LABORATORY HANDBOOK. M. G. Scroggie, B.Sc., M.I.E.E. 6th Edition ...	25/-	26/6
ELECTRONIC COMPUTERS: Principles and Applications Edited by T. E. Ivall ...	25/-	25/9
TELEVISION EXPLAINED. W. E. Miller, M.A. (Cantab.), M.Brit.I.R.E. Revised by E. A. W. Spreadbury, M.Brit.I.R.E. Sixth Edition ...	12/6	13/3
ABACS OR NOMOGRAMS. A. Glet ...	35/-	35/10

A complete list of books is available on application

Obtainable from all leading booksellers or from

ILIFFE & SONS LTD., Dorset House, Stamford Street, London, S.E.1

ably revised as the result of discoveries based on observations and on the records made by the instruments we send aloft.

Printed Circuits

THE increasing use of printed circuitry in both sound and television sets is undoubtedly a good thing. You can, of course, make good, sound joints of low resistance by soldering; but the trouble is that it's so easy for the careless (or perhaps tired) factory hand to make bad ones, and the dry joint is one of the biggest of dealers' and servicemen's headaches. Every set is supposed to be most carefully inspected during the various stages of its progress along the assembly line, and I've no doubt that it is. But it's extraordinary that so many dry joints should escape notice. Dealers have shown me several in new sets straight out of their cartons. A wartime experience I shan't forget is receiving a GL2 radar receiver, which had come about 50 miles over good roads. It wouldn't work and the reason, we found, was that there were over a score of dry joints in its superhet.

Radio Exports

OUR exports of capital equipment, domestic receivers and recording gear and of valves, c.r. tubes and components are rapidly becoming a very important item in the country's overseas trade. Their sales in markets abroad have grown amazingly fast. In 1947 we thought we weren't doing too badly by exporting £10.2M worth of such goods. At the end of 1955 the total for the year had reached the then all-time record of £33M. But last year was a long way beyond this with £40.3M. Thus in the 10 years 1947-1956 inclusive the industry's exports of radio and electronic equipment have increased fourfold—a really wonderful achievement.

Built-in Aerials

THE little town in which I now live must be a good 150 miles from Wrotham; yet I've received the London programmes quite well at times with a set using a built-in aerial and working in a ground-floor room. Sometimes these aerials may be effective enough, but that may be their undoing, for they pick up every bit of interference that's going on Band II. One friend complained almost tearfully about the motor-car ignition interference he was getting. I told him I was pretty sure he'd get rid of it, if he had an outdoor aerial put up. He did and he has.

SEND NOW

FOR THESE INFORMATION LEAFLETS

FREE ON REQUEST.

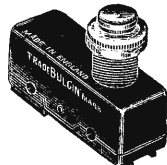

MICRO SWITCHES

Sensitive, yet positive and trouble-free action. Guaranteed for over half-million operations. Fitted with the unique "Rolling-spring" action. Standard, Miniature, Sub-miniature and Open-blade models for many uses.

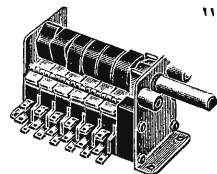

"POLYMICRO"

This unique mains-operated ganged multi-pole switch is available in many combinations of switching arrangements and is operated by polished bakelite cams on a hexagonal shaft.

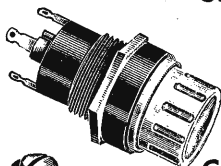

SIGNAL LAMPS

The range of Bulgin Signal-lamps is vast, and covers types for mains and low-voltage uses and all lamp-acceptances from the tiny L.E.S. to the larger Mains-V. B.C. and including the Continental C.E.S. fittings.

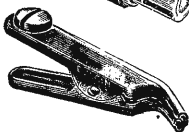

CROCODILE CLIPS

Undoubtedly the most useful accessories ever designed. Millions have been sold since being introduced by Bulgin in 1923, and continue in active use. Strong sharp teeth, positive grip.

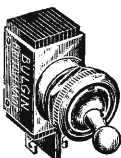

SWITCHES

Laminated and metal-clad, moulded, single and double pole, heavy duty and standard types, long, short or standard bush, "pear," "hall" or "slotted" dollies, solder-tags or screw-terminals, chrome, nickel, black-nickel or various other platings. All guaranteed for 25,000 operations. 180 listed types and variations available to quantity orders.

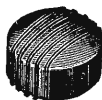

CONTROL KNOBS

Manufactured in glossy Bakelite or Polystyrene and generally fitted with heavy brass anti-fracture insert for grub-screw. Modern designs are continually being added to the range.

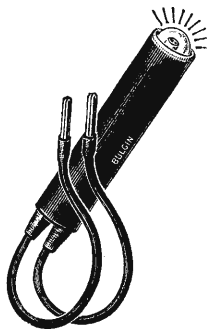

TEST PRODS

Standard models, with or without "uses. Slender-handle "twist-grip" model and the Neon test-prod are also shown with instructions in this information leaflet.



Also included in the BULGIN range are Fuses and Holders, Couplers, Capacitors, Chokes, Jacks and Jack Plugs, Mains and low voltage connectors, Resistors, Pilot Lamp-holders, Thermal-cut-outs and fasher units, Terminals, Valve-holders and valve-top-connectors, Tag strips and group boards, etc. Full details in CATALOGUE 196/WW, price 1/- post free.

BULGIN

THE CHOICE



OF CRITICS

A. F. BULGIN & CO. LTD. BARKING, ESSEX

Rippleway 5588

Ateliphony

IN THE February issue I pointed out that, in readiness for the day when radio transmission of power bursts upon us, we ought to equip ourselves with a snappy, but correctly derived, word for it, lest some wretched hybrid like "dynamission" be foisted upon us. A correspondent points out that in Webster's dictionary (1910 edition) the word "telekino" is given as meaning "An apparatus for transmission of electrical energy without a conducting wire."

Such a revelation almost caused me to lose the respect I have always felt for Mr. Webster but, on reflection, I realized that it is the duty of a lexicographer to record "English as she is spoke." The word "telekino" can only mean something to do with "motion at a distance"; only by fantastic stretching could it mean "power transmission."

Another correspondent tells me that I am incorrect in thinking that the word "telephone" could, with equal accuracy, be applied to a speaking tube. He says that the coinor of this word originally intended it to be written telfone and that it was altered by some ignorant scribe who thought a spelling error had been made. If this be true then it would certainly imply transmission of speech over a wire, for the word "teli" (τελι) is given as meaning "wire" in a modern Greek lexicon. There are certainly some grounds for belief in what my correspondent says as at the time the telephone came into existence the followers of Byron had definitely put modern Greece and its language on the map.

Surely the acceptance of the foregoing explanation should enable us to jettison the cumbrous expression radio-telephony for the simpler ateliphony, as "ateli" would literally mean "wireless."

We could even speak of ateligraphy, although there can be no doubt that the word telegraph was coined long years before the invention of wired telegraphy. It was first used in 1794 to describe the semaphore system, invented by the Frenchman Chappe, which was installed on the roof of the Admiralty to give hill-to-hill communication with Portsmouth and elsewhere.

Operation Phoenix

WE often hear speculation about the origin of cosmic radiation which reaches us from outer space. I believe these radiations to be man-made but I certainly don't think they are messages from the inhabitants of some other world.

I hold firmly to the theory that many times in the 4×10^9 years since this planet started on its travels, mankind has attained to a degree of scientific knowledge which it is now once more approaching. In previous eras of civilization man managed to split the atom and brought civilization to the brink of the abyss just as we have done now.

But before all hell was let loose it occurred to somebody like myself to record all scientific and other knowledge, literature and works of art both visual and aural so that a future civilization would know what manner of men they were. The problem was to know where to store these precious records so that they would be free from destruction by earthquakes, by moth and rust and by the depredations of a new race of primitive man which would arise phoenix-like from the ashes of the old world.

Clearly the only space to store them was in the indestructible ether. It was obvious, for instance, that if, say, a page of a scientific textbook was scanned and radiated by the usual television technique, using a wavelength sufficiently short to penetrate the various ionized layers, it would get out into outer space. If beamed at the moon it would return in two to three seconds, but by beaming it at one of the giant nebulae it could be made to return in, say, 30 million years, or at any time desired, by choosing the right nebula.

It is my belief that these present cosmic radiations are the preliminary warning signals, the series of ... — which every wireless man knows. These signals are heralding the coming of amazing data concerning this former civilization.

Optical Turret TV

I WAS interested to read in the February issue that "Diallist," like myself, favours projection television receivers. I certainly didn't know that one of the snags was the difficulty in getting servicemen with the necessary skill to adjust the optical system but I do appreciate the skill needed in optical work.

I recollect once throwing my binoculars out of the bedroom window at a loveorn tomcat sitting on the fence crooning to a fellow feline of the opposite sex. Apart from getting me a warning from one of the animal protection societies, my action put the prisms of the binoculars out of collimation. I tried re-collimating them myself but, I can assure you, never again.

I do not see, however, why the optical system in a TV receiver could



Decrooning and de-collimating

not be made as robust as that of a first-rate home-ciné projector with the same sort of woman-proof focusing arrangement. In fact I would go further and suggest two lenses of different focal lengths mounted on a rotating turret such as is used nowadays in some amateur ciné cameras, and in all professional ones.

My idea is simply to make the picture fit the audience. I would have a large screen so that when several people were viewing the picture would fill the screen and they could all sit well back and view in comfort. For more intimate viewing, when there were only Mrs. Free Grid and myself, I would prefer to draw our chairs up a little closer to the screen. To avoid eyestrain of the hat-peg type I would swing the turret round to change the lens and so obtain a smaller picture on the same screen. I do know what I am talking about as I have done the same thing with a lens turret on a home-ciné projector: this optical turret TV receiver will, I feel sure, be the set of the future and the sooner manufacturers get down to it the better.

"Radio Cosmos"

SPEAKING as one who has been a reader of *W.W.'s* sister journal, *Electronic & Radio Engineer*, since the days when it was called *Experimental Wireless* and right through the years when it was *Wireless Engineer*, I don't altogether approve of the disappearance of the good old word "wireless" from the title.

I am not unmindful of the fact that "this 'ere progress; it goes on," as one of H. G. Wells' characters said, but all the same I hope the editor of *W.W.* doesn't contemplate making a similar change. There is no more solid and down to earth title than *Wireless World*. It smacks of solid and sober reliability.

May the day be long deferred when *Wireless World* becomes *Radio Spheroid* or even *Radio Cosmos*.